

Notice

Updating or revising this manual or making any changes to the information herein will be initiated when the company deems it necessary. The company reserves the right to take the above-mentioned actions and is under no obligation to notify any person of such actions in advance or afterwards.

1997

Trademarks

IBM PC, OS/2, PS/2, EGA, and VGA are registered trademarks of International Business Machines Corporation.

Intel, Pentium are trademarks of Intel Corporation.

MS-DOS, Microsoft Windows, Windows NT and Microsoft Mouse are registered trademarks of Microsoft Corporation.

Sound Blaster Pro is a trademark of Creative Labs, Inc.

SystemSoft is a registered trademark of SystemSoft Corp.

Other brand and product names are trademarks of their respective companies.

FCC Notice

This equipment has been tested and found to comply with the limits for a Class B digital device, pursuant to Part 15 of the FCC Rules. These limits are designed to provide reasonable protection against harmful interference in a residential installation. This equipment generates, uses, and can radiate radio frequency energy and, if not installed and used in accordance with the instructions, may cause harmful interference to radio communications. However, there is no guarantee that interference will not occur in a particular installation. If this equipment does cause harmful interference to radio or television reception, which can be determined by turning the equipment off and on, the user is encouraged to try to correct the interference by one or more of the following measures:

- Reorient or relocate the receiving antenna.
- Increase the separation between the equipment and receiver.
- Connect the equipment into an outlet on a circuit different from that to which the receiver is connected.
- Consult the dealer or an experienced radio/TV technician for help.

CE – Certificate

This equipment is in compliance with the requirements of the following regulation:

EN 55 022: CLASS B

Warranty Provisions

Keep the product's bar code legible to protect your right for warranty services.

The manufacturer warrants this personal computer to be in working order for a period of one year from the date of shipment. If this product fails to be in working order during the one year warranty period, the manufacturer will, with its option, repair or replace the product at no charge except as set forth below.

Warranty service will be furnished on an exchange basis. The manufacturer may repair or replace your product with a new or reconditioned one. Any replaced components or parts become the property of the manufacturer.

No warranty is expressed or implied for products damaged by accident, abuse, misuse, acts of god, or un-authorized modification. No warranties apply after the one year warranty period.

To obtain warranty service described herein, deliver the product along with proof of purchase date, to any of the manufacturer's authorized distributors during the warranty period. The owner agrees to insure the product and assume the risk of damage or loss in transit, to pay in advance all shipping charges, and to use the original shipping container (or the equivalent).

The manufacturer is not liable to any purchaser for damage, lost revenue, lost wages, lost savings, or any other incidental or consequential damages arising from the purchase or use of the product or inability to use it.

Important Safety Instructions

Please read and follow these important instructions.

1. Follow all warnings and instructions marked on this product.
2. Unplug this product from the wall outlet before cleaning it or connecting peripheral devices.
3. Use a damp cloth with mild soap to clean this product. Do not apply cleaner directly to the unit. Do not use volatile or abrasive cleaners on this product.
4. Do not place this product on an unstable surface where it may fall.
5. Do not block or cover the system's ventilation openings. Also, never place this product near or over a radiator or heat register, or in a built-in installation unless adequate ventilation is provided.
6. Operate this product in accordance with its rated power specifications. If you are unsure of your local power specifications, consult your dealer or local power company.
7. This product is equipped with a 3-wire grounding type plug. This is an important safety feature; do not defeat its purpose. If you do not have access to such power, have a qualified electrician install a proper outlet.
8. Do not allow anything to rest on the power cord. Do not locate this product where persons will likely walk on the cord.
9. If an extension cord is used with this product, make sure the total current drawn by the products plugged into the extension cord do not exceed the extension cord or outlet power ratings.

10. Do not allow foreign matter to enter the system.
11. Do not attempt to service this product yourself. Opening or removing covers may expose dangerous voltage points. Refer all repair work to qualified service personnel.
12. Unplug this product from the wall outlet, do not operate it, and immediately seek proper servicing if:
 - The power cord or plug is damaged or frayed.
 - Liquid or foreign matter has entered this product.
 - This product has been exposed to rain or water.
 - This product has been dropped or damaged.
 - This product exhibits a distinct change in performance, indicating a need for service.
13. Do not use any battery pack other than the one specifically designed for this system. Batteries may explode or leak if exposed to fire or improperly handled or guarded. Refer battery replacement to your dealer or qualified service personnel.
14. Only use UL listed/CSA certified, type SVT/SJT power cords rated 6A 250V minimum (VDE approved or equivalent). It should be a detachable type with a minimum length of 6 feet.
15. Adjust only those controls that are covered by these operating instructions. Improper adjustment of other controls may result in serious damage to the system which is not covered by the warranty.

Conventions

This manual uses the following conventions to describe, identify, and highlight terms and operating procedures.

Text Conventions

Text in boldface contains messages that are important for safe operation. Please read.

Characters in boldface represent specific items or keys, e.g. **CardBus**, **Fn** key.

File names are presented in bold capitals, e.g. **A:\>0VMAKFIL /Pn**.

Abbreviations

For the purpose of clarity, abbreviations are enclosed in parentheses following their definition; for example, Enhanced Parallel Port (EPP) mode.

Icons

Icons identify ports and jacks of the Notebook computer. The system status indicators are also identified with their relative icons.

Keys

Keys appear in boldface. A plus sign (+) between two keys indicates that they should be pressed simultaneously.

Messages

Note: A note is an advice that helps you make best use of your Notebook computer. Please read.

Ergonomics

Developing good work habits is important for you if you need to work in front of the computer for a long period of time. Improper work habits can result in discomfort or serious injury from repetitive strain to your hands, wrists or other joints. Following are some tips to reduce the strain:



- Adjust the height of the chair and/or desk so that the keyboard is at or slightly below the level of your elbow. Keep your forearms, wrists, and hands in a relaxed position.
- Your knees should be slightly higher than your hips. Place your feet flat on the floor or on a footrest if necessary.
- Use a chair with back and adjust it to support your lower back comfortably.
- Sit straight so that your knees, hips and elbows form approximately 90° angles when you work.

Lighting

Proper lighting and comfortable display viewing angle can reduce eye strain and muscle fatigue in your neck and shoulders.

- Position the display to avoid glare or reflections from overhead lighting or outside sources of light.
- Keep the display screen clean and set the brightness and contrast to levels that allow you to see the screen clearly.
- Position the display directly in front of you at a comfortable viewing distance.
- Adjust the display viewing angle to find the best position.

In addition, continuous concentration on computing work can result in discomfort and injury. Remember to:

- Alter your posture frequently.
- Stretch and exercise your body several times a day.
- Take periodic breaks when you work at the computer for long periods of time. Frequent and short breaks are of greater benefit than fewer and longer breaks.

Table of Contents

Chapter 1: Getting Started

Unpacking	1-2
Operating Environment	1-3
Quick Starting-up.....	1-4
Powering the System	1-4
AC Power Adapter	1-4
Battery Pack	1-5
Inserting	1-5
Removing	1-5
Recharging by AC Power	1-6
Proper Handling of the Battery Pack.....	1-6
Opening the LCD Cover	1-7
Top-Front View	1-8
LCD Panel	1-8
Stereo Speakers.....	1-8
Trackpad and Buttons	1-8
Keyboard	1-8
System Status LED Indicators	1-8
Microphone	1-8
System Status Indication.....	1-10
LED Indicators on the LCD Cover	1-10
LED Indicators on the Top Panel.....	1-11
Button.....	1-11
Rear View	1-13
AC-in Socket	1-13
Security Connector.....	1-13
Parallel Port.....	1-13
S-video Jack.....	1-13
RCA Jack.....	1-13
Expansion Port	1-13
Dual USB Ports.....	1-13
Serial Port	1-13
External Monitor (CRT) Port	1-14
Dual PS/2 Type Ports	1-14

Right-side View.....	1-15
PC Card Sockets.....	1-15
2.5" Hard Disk Drive.....	1-15
3.5" Floppy Diskette Drive.....	1-15
Speaker-out Jack.....	1-15
Line-in Jack.....	1-15
Microphone-in Jack.....	1-15
Ventilation.....	1-16
Right-side Stand.....	1-16
Left-side View.....	1-17
5.25" CD-ROM Drive.....	1-17
Infrared.....	1-17
Left-side Stand.....	1-17

Chapter 2: Operation

Upgrading CPU.....	2-2
Replacing CPU.....	2-2
Jumper Settings.....	2-3
For P54C.....	2-3
For P55C.....	2-4
Setting DIP Switch.....	2-5
CPU Core Frequency.....	2-5
Flash ROM BIOS.....	2-6
Accessing DIP Switch.....	2-6
CPU Core Voltage.....	2-8
Accessing DIP Switch.....	2-8
CPU I/O Voltage.....	2-9
Accessing DIP Switch.....	2-9
Expanding Memory.....	2-10
Installing Memory Module.....	2-12
Removing Memory Module.....	2-13
Using Hard Disk Drive.....	2-14
Removing.....	2-14
Inserting.....	2-14
Using Floppy Diskette Drive.....	2-15
Inserting/Removing Diskettes.....	2-15
Replacing Floppy Disk Drive.....	2-16

Using CD-ROM	2-17
Removing CD-ROM Module	2-18
Loading Compact Discs	2-19
Handling of Compact Discs	2-20
Using PC Card Sockets	2-21
Inserting PC Cards	2-22
Removing PC Cards	2-22
Using Hot Keys	2-23
Using Numeric Keypad	2-25
Windows 95 Special Keys	2-26
Application Key	2-26
Windows Key	2-26
TV-Output	2-27
LCD Panel	2-28
Using Power Management	2-29
Advanced Power Management (APM 1.2)	2-29
Advanced Configuration and Power Interface (ACPI)	2-29
Global Standby	2-30
Suspend and Resume	2-30
Powered On Suspend (POS)	2-31
Resume from POS Mode	2-31
Suspend To RAM (STR)	2-31
Resume from STR Mode	2-31
Suspend To Disk (STD)	2-32
Resume from STD Mode	2-32

Chapter 3: BIOS Utilities

Power On Self Test (POST)	3-2
POST Message: Normal Operation	3-2
POST Message: Error Detected	3-3
System Configuration Utility	3-4
Information in the System Configuration Utility	3-4
Invoking the System Configuration Utility	3-5
Working with the Menu Bar of the SCU	3-6
Working with the Pull-down Menu of the SCU	3-7
Features of the System Configuration Utility	3-8

Startup Menu.....	3-8
Memory Menu	3-10
Disks Menu.....	3-11
Components Menu.....	3-13
Power Menu	3-16
Exit Menu.....	3-19

Chapter 4: Peripheral Devices

Attaching a Security Lock	4-2
Attaching a Parallel Printer	4-3
Attaching a TV Set	4-4
Attaching a Video Input Device	4-5
Attaching a USB-compatible Device	4-6
Attaching a Serial Mouse	4-7
Attaching an External Monitor (CRT)	4-8
Attaching a PS/2 Keyboard or Mouse	4-9

Appendix A: Specifications.....	A-1
--	------------

Appendix B: I/O Port Pin Assignments	B-1
---	------------









Chapter 1: Getting Started

This chapter provides a short introduction and tutorial that will familiarize you with the Notebook system and get you up and running quickly.

Unpacking	1-2
Operating Environment	1-3
Quick Starting-up	1-4
Powering the System	1-4
AC Power Adapter	1-4
Battery Pack	1-5
Opening the LCD Cover	1-7
Top-Front View	1-8
System Status Indication.....	1-10
LED Indicators on the LCD Cover	1-10
LED Indicators on the Top Panel.....	1-11
Button	1-11
Rear View	1-13
Right-side View.....	1-15
Left-side View	1-17

Unpacking

Carefully unpack the Notebook Computer and the included accessories (Figure 1-1). If there is any discrepancy or problem, contact your dealer immediately. Be sure to save the packing materials in case you need to repack and ship the Notebook back in the future.

-  Notebook Computer.
-  Carrying Bag.
-  Power Adapter.
-  Power Cord.
-  User Manual.
-  PS/2 Transfer Cable.
-  Battery Pack.
-  Utilities Diskette(s).

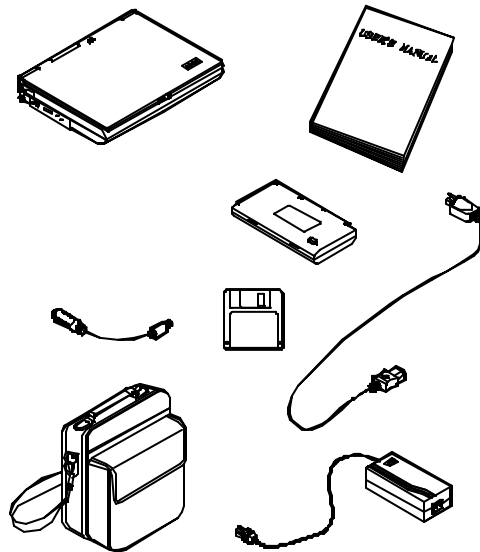





Figure 1-1

Operating Environment

As with any other precision electronic equipment, proper care and operation of your Notebook will provide long and reliable service. Be sure the computer system should not be:

-  Exposed to excessive heat or direct sunlight.
-  Subjected to shock or vibration.
-  Exposed to strong magnetic fields.
-  Left in a place where foreign matter or moisture may enter the system.

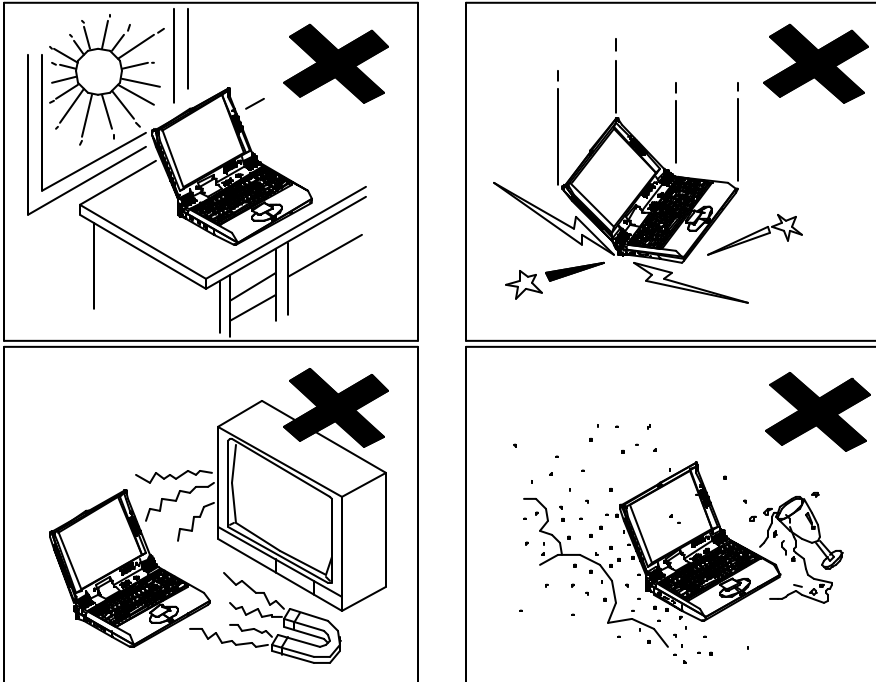

Figure 1-2

Quick Starting-up

Powering the System

AC Power Adapter

Use only the power adapter that comes with your Notebook Computer. System operation with an incorrect power adapter will cause damage to the Notebook and its components.

1. Plug the power adapter to the AC-in socket on the rear panel of the Notebook.
2. Connect the power cord to the power adapter.
3. Plug the AC power cord into a properly grounded outlet (Figure 1-3).
4. Refer to Chapter 1, System Status Indication for more information on system power status.

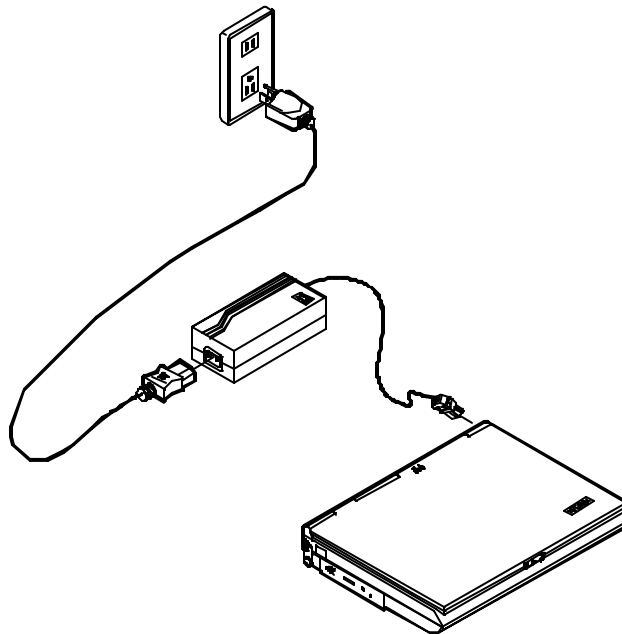

Figure 1-3

Battery Pack

The Notebook system can be powered by the battery pack for continuous portable operation without an external power source when you take it away from the office. However, the actual operating time will be dependent upon the application you use and the configuration you set.

Inserting

1. Turn the Notebook over.
2. Position the battery pack at a slight angle and firmly fit it into the Notebook.
3. Install the four screws that fasten the battery pack (Figure 1-4).

Removing

1. Turn the Notebook over.
2. Remove the four screws that fasten the battery pack.
3. Carefully lift the battery pack from the Notebook.

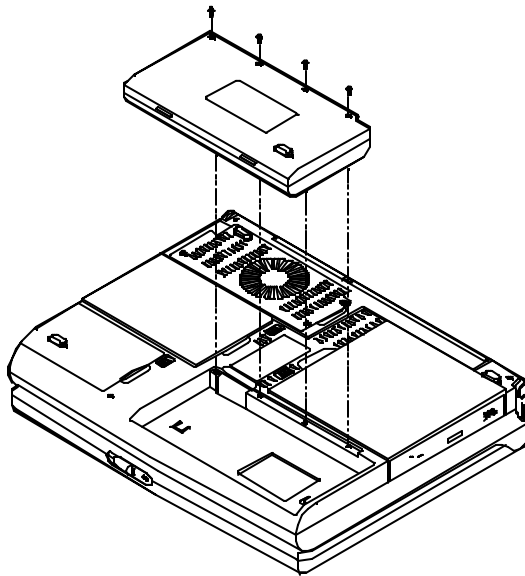

Figure 1-4

Recharging by AC Power

The system's battery pack will recharge whenever the system is plugged into the AC power supply, regardless if the system is being operated or not.

- You may connect the AC power adapter to the Notebook Computer at any time to begin recharging the system's battery pack. You do not need to turn off the system's power.
- Hours may be needed to recharge the battery pack.
- Please refer to Chapter 1, System Status Indication for more information concerning battery charge status.

Proper Handling of the Battery Pack

- Do not attempt to disassemble the battery under any circumstances.
- The battery may explode if exposed to fire or high temperatures.
- Avoid short circuit the battery by the metal terminals (+, -).

Opening the LCD Cover

1. Slide the top cover latch to the right to release the latch (Figure 1-5).
2. Lift the top cover to reveal the LCD panel and keyboard (Figure 1-6).
3. Adjust the LCD panel to a comfortable viewing angle.
4. Press the power button to turn the system on or off.

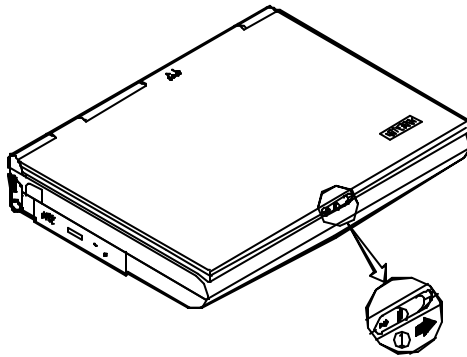

Figure 1-5

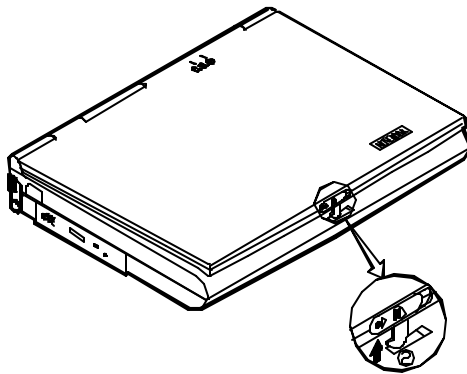

Figure 1-6

Top-Front View

LCD Panel

The Notebook provides you with the solution of big LCD panel. Depending upon the model you have purchased, it can either be 15.1" XGA (1024x768 pixels) compatible, of TFT technology or 13.8" XGA (1024x768 pixels) compatible, of DSTN technology. The LCD panel is driven by a PCI local bus video controller with 4MB video memory.

Stereo Speakers

Two built-in speakers provide clear 3D stereo sound.

Trackpad and Buttons

The pointing device features a sensitive glide pad for precise movements. It functions like a two-button mouse does. The right trackpad button is equivalent to the right mouse button; the left trackpad button is equivalent to the left mouse button.

Keyboard

The Notebook utilizes a 102-key Windows 95 keyboard that is integrated with the numeric keypad. It is detachable for various language versions. You may refer to Chapter 2: Operation for more information.

System Status LED Indicators

The LED indicators display the system's operation status. Please refer to Chapter 1, System Status Indication for more information.



Microphone

This is the built-in microphone.

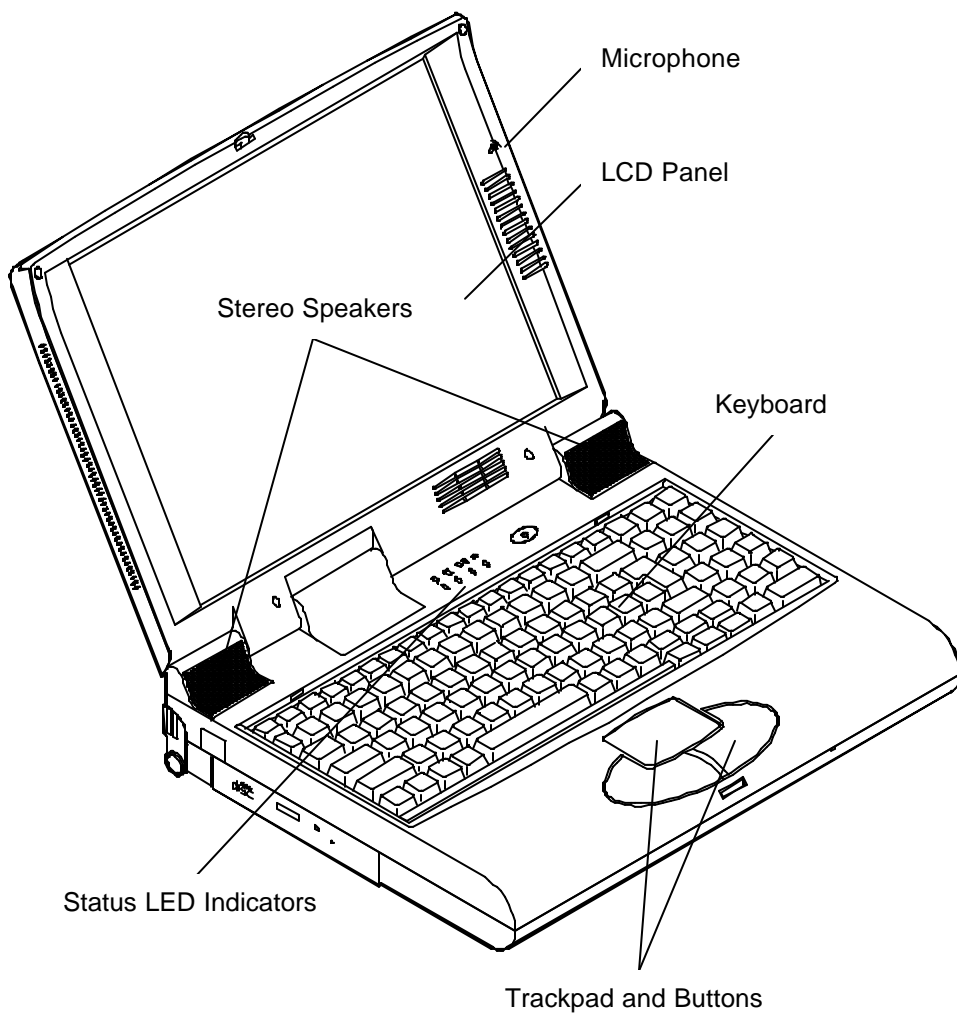

Figure 1-7

System Status Indication

LED Indicators on the LCD Cover

Icon	Color	Description
①	Green	Battery power is used with system turned on.
	Red	AC power is used with system turned on or off.
🔋	Green	Battery is fully charged.
	Red	Battery is being charged.
	Blinking Red	Battery power is critically low.

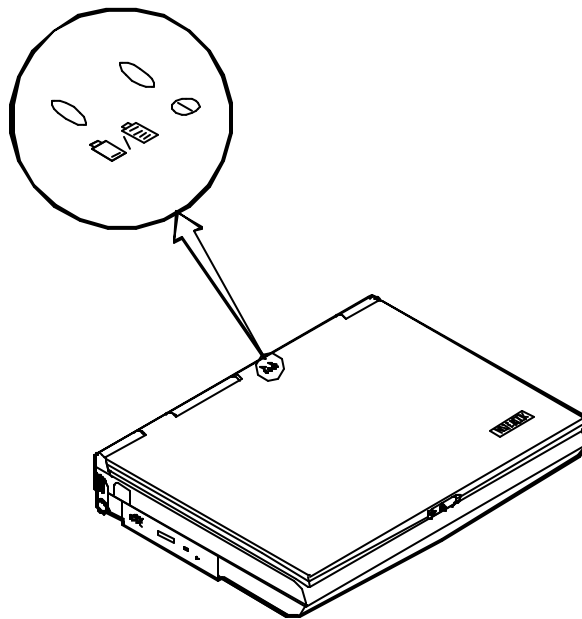







Figure 1-8

LED Indicators on the Top Panel

Icon	Color	Description
	Green	Battery power is used with system turned on.
	Red	AC power is used with system turned on or off.
	Green	Battery is fully charged.
	Red	Battery is being charged.
	Blinking Red	Battery power is critically low.
	Green	The hard disk drive is being accessed.
	Green	The system has entered the configured suspend mode (either POS or STR mode).

Button

Icon	Description
	<p>Toggle this button to turn the system on or off.</p> <p>After proper configuration under SCU, this button can be used as suspend/resume hot button (refer to Chapter 3: BIOS Utilities, Power Menu for more information).</p>

Note: After turning off the system, wait for a few seconds to power it on again.

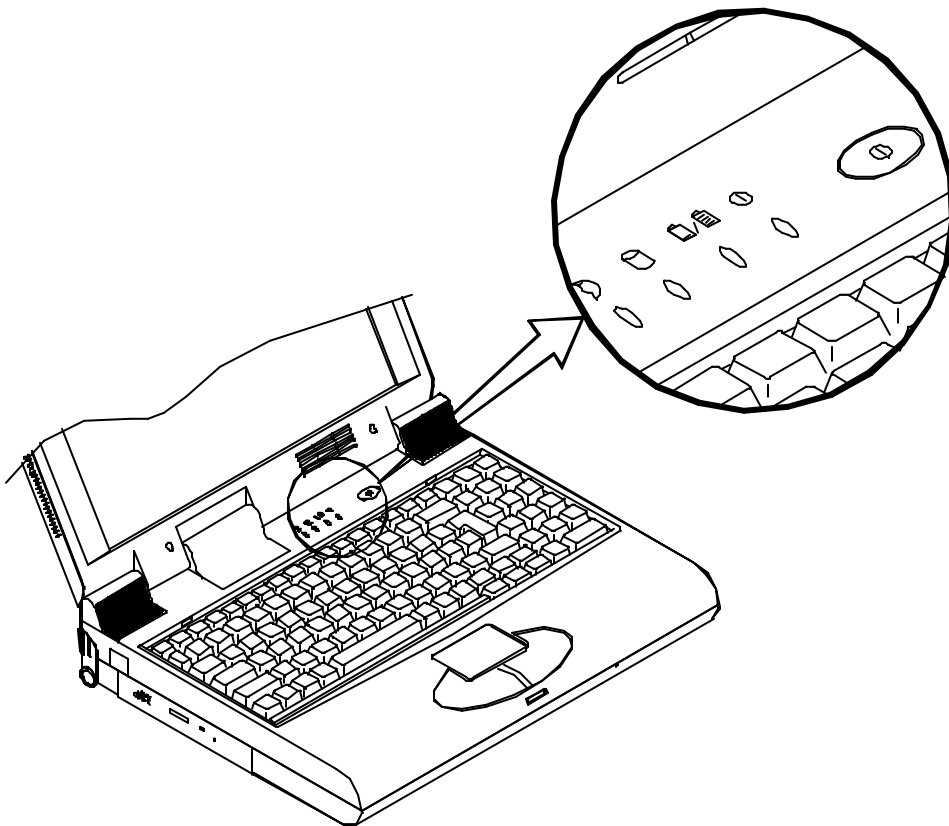

Figure 1-9

Rear View

AC-in Socket

Plug the AC adapter into this connector for power supply. To disconnect the power adapter, pull the plug (not the cord) directly back.

Security Connector

It is used to protect your Notebook from being stolen. Wrap the steel cable around your desk. Next, insert the locking device into this security connector.

Parallel Port

This parallel port supports EPP (Enhanced Parallel Port) and ECP (Extended Capabilities Port) modes.

S-video Jack

Use this jack to transmit video signal to a TV set. You may need to select the video standard (NTSC/PAL) for video display (please refer to Chapter 3, Components Menu for more information).

RCA Jack

This jack accepts analog composite signals inputted into the system from external video devices, e.g. camera, CCD.

Expansion Port

This port is used to connect the proprietary Port Replicator.

Dual USB Ports

The dual Universal Serial Bus (USB) ports simplify the expansion capability for peripheral devices.

Serial Port

This port is UART 16C550 compatible. It features a 9-pin connector to connect an external mouse for example.



External Monitor (CRT) Port

This port is used for display output to an external monitor. Simultaneous display with the LCD panel is available.



Dual PS/2 Type Ports

External PS/2 mouse and keyboard are allowed to connect to the system via both ports.

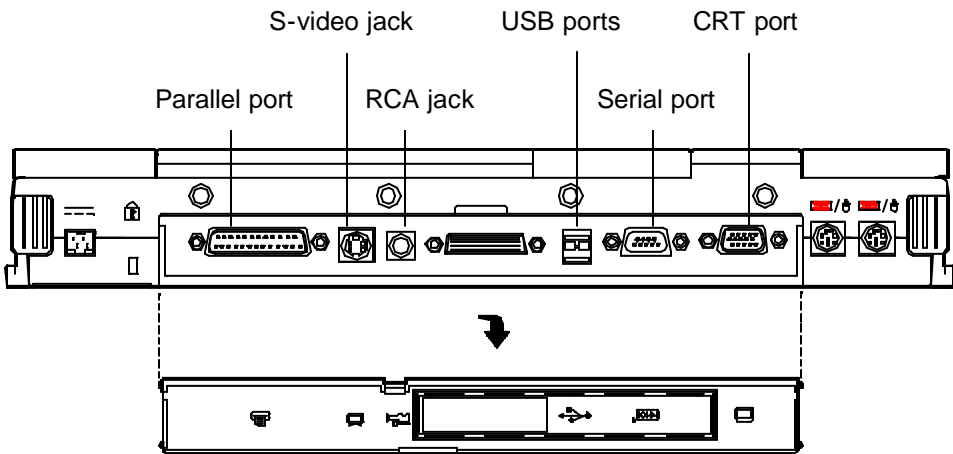

Figure 1-10

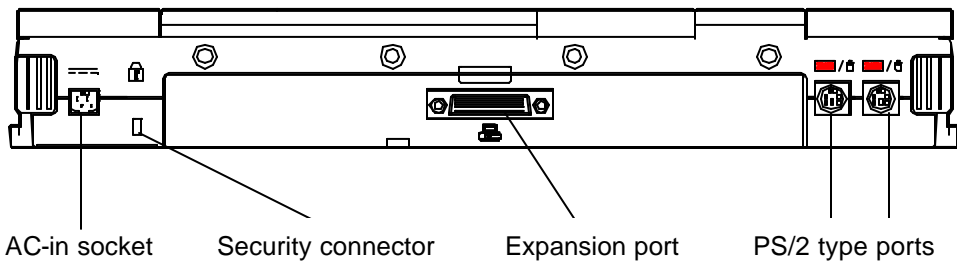

Figure 1-11

Right-side View

PC Card Sockets

One Type III or two Type II PC cards may be used. Both sockets will expand the system capabilities when a PC card is inserted. To eject the PC card, press the appropriate eject button (Figure 2-17).

2.5" Hard Disk Drive

The 2.5" hard disk drive is designed to be removable. It accepts any 2.5" IDE hard disk drive with a height of 12.7mm or less. Refer to Chapter 2: Operation for more information.

3.5" Floppy Diskette Drive

The Notebook comes standard with a 1.44MB floppy drive installed. You may press the button on its top-right side for diskette ejection. The floppy disk module can be replaced with optional accessory, such as the secondary 2.5"/3.0" hard disk drive or Zip drive (Refer to Chapter 2: Operation for more information).



Speaker-out Jack

Headphone and speakers can be attached to the system through this jack.



Line-in Jack

External audio source can be fed into the Notebook through this jack.



Microphone-in Jack

Use this jack to connect a microphone to the system.

Ventilation

The Notebook features the ventilation to dissipate the system's operating heat. Do not block or obstruct it during operation.

Right-side Stand

Move this stand (together with the left one) to adjust the typing angle. **If a high speed CPU is installed on the system, erecting the stands on both sides will be necessary for heat dissipation during operation (Figure 1-13).**

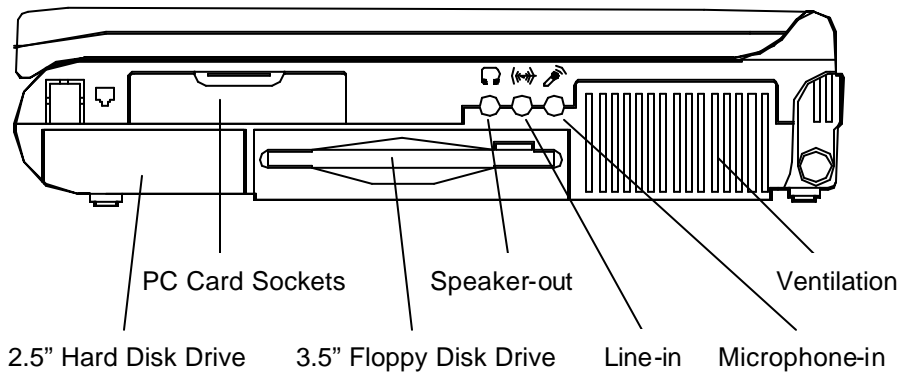

Figure 1-12

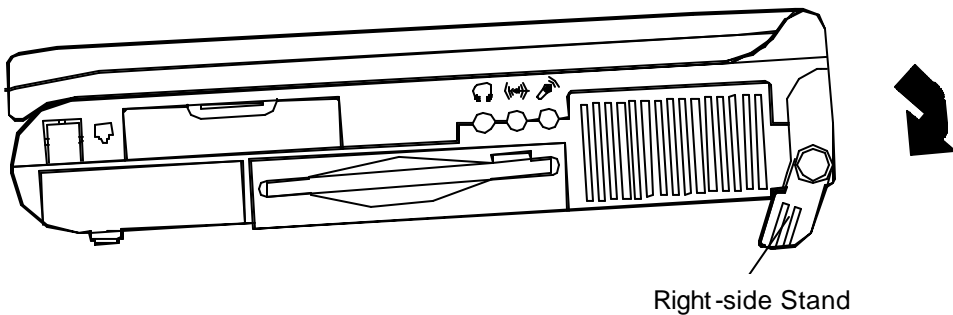

Figure 1-13

Left-side View

5.25" CD-ROM Drive

The 5.25" IDE CD-ROM module is designed to be removable from the Notebook. The eject button is located in the middle of the front cover of the CD-ROM drive. Pressing it will release the CD tray.

Infrared

The system adopts infrared technology as the interface for simple, fast and convenient data exchange from the Notebook to an infrared-compatible device. It implements IrDA (HPSIR), Amplitude Shifted Keyed IR (ASKIR), and Fast IR (FIR). No object should be blocked in each other's line of sight between the Notebook and the infrared-equipped device. Refer further to the manual of the cordless connected device on how to use the point-and-shoot operation.

Left-side Stand

Move this stand (together with the right one) to adjust the typing angle. **If a high speed CPU is installed on the system, erecting the stands on both sides will be necessary for heat dissipation during operation** (Figure 1-15).

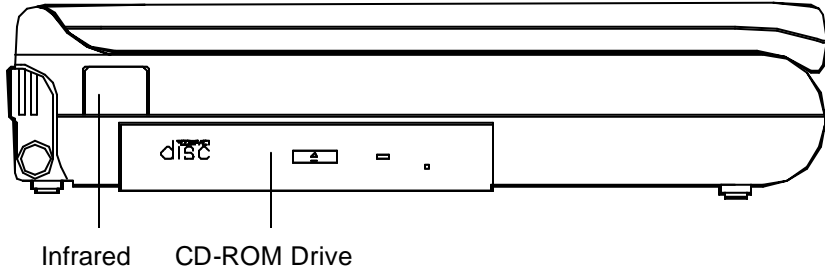

Figure 1-14

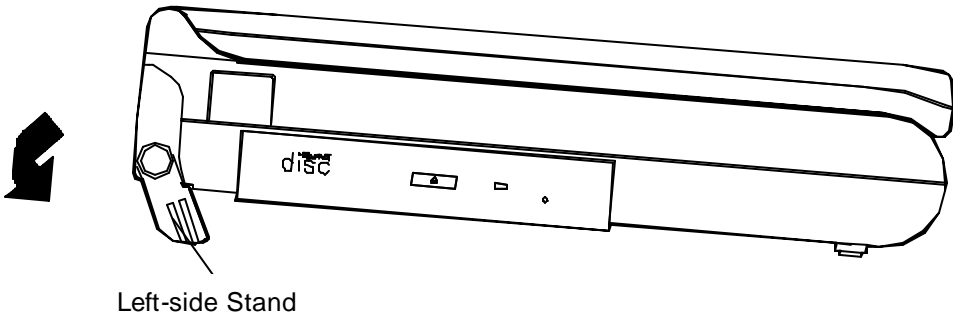

Figure 1-15

Chapter 2: Operation

The Notebook has many advanced features to help you with your computing work. This chapter describes each of the Notebook's hardware features and shows you how to use them.

Before you begin working with any internal components of the Notebook, remove the battery and disconnect the AC power adapter.

Make sure that you wear an anti-static wrist strap to ground yourself before working with any internal components of the Notebook. Static electricity may damage components beyond repair.

Upgrading CPU.....	2-2
Jumper Settings.....	2-3
Setting DIP Switch	2-5
CPU Core Frequency	2-5
Flash ROM BIOS	2-6
CPU Core Voltage.....	2-8
CPU I/O Voltage	2-9
Expanding Memory.....	2-10
Using Hard Disk Drive	2-14
Using Floppy Diskette Drive	2-15
Using CD-ROM	2-17
Using PC Card Sockets.....	2-21
Using Hot Keys	2-23
Using Numeric Keypad.....	2-25
TV-Output	2-27
LCD Panel	2-28
Using Power Management	2-29

Upgrading CPU

The system is capable of hosting a wide range of Intel CPUs' speed. Upgrading your CPU will increase your computing speed. The higher the CPU speed you install, the better the system performance you get. Different CPUs may have different power voltages. If you want to upgrade the CPU, remember to adjust the correspondent settings.

Replacing CPU

1. Remove all power sources (AC power and battery).
2. Turn the Notebook over.
3. Remove the CPU cover.
4. Remove the screws that fasten the heat sink mounted on the CPU (Figure 2-1).

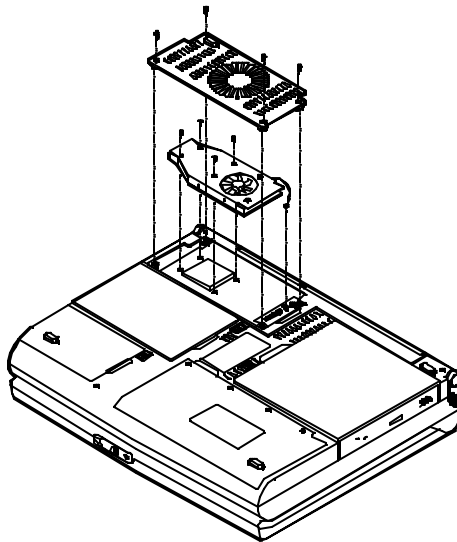

Figure 2-1

Note:

- Contact your dealer for the **proprietary tool** to replace the CPU.
- Wait for the CPU to cool down before you start to replace it.

Jumper Settings

You need to adjust the jumper settings for different CPU types.

For P54C

CPU Type	Jumper Setting	Remark
P54C	JP2 short	See Figure 2-2

Set **JP2** short by attaching the cap into it. Refer to Figure 2-2.

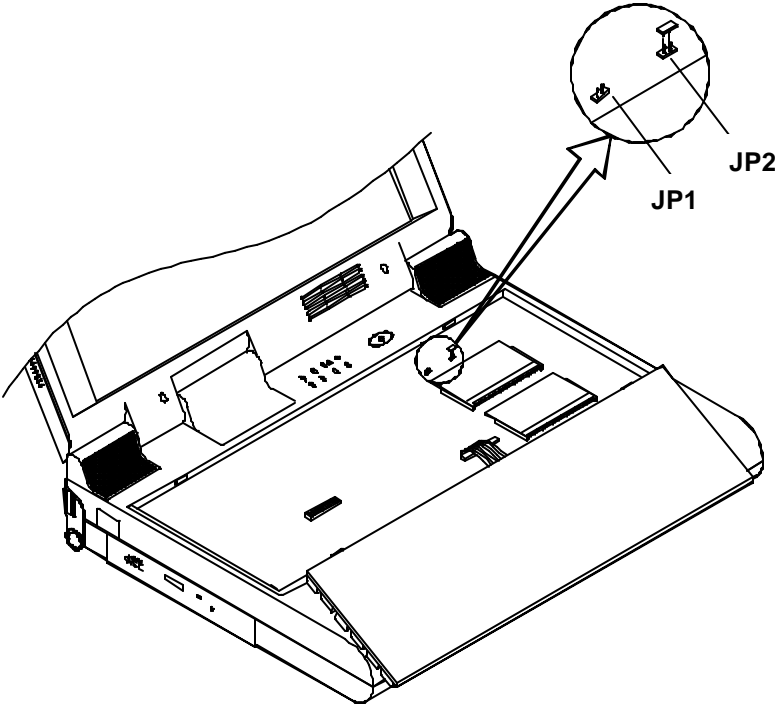

Figure 2-2

For P55C

CPU Type	Jumper Setting	Remark
P55C	JP1 short	See Figure 2-3

Set **JP1** short by attaching the cap into it. Refer to Figure 2-3.

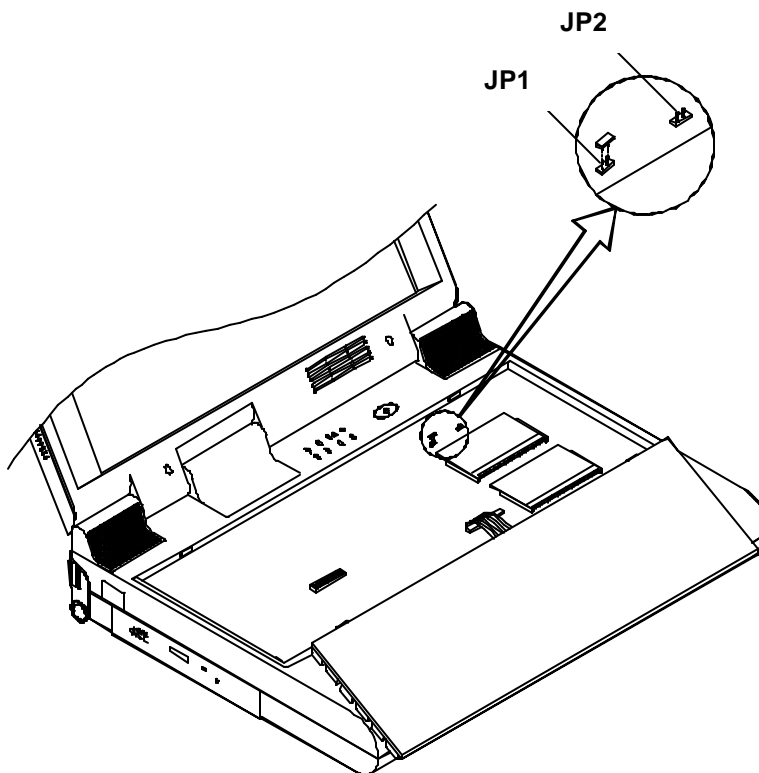

Figure 2-3

Setting DIP Switch

CPU Core Frequency

Remove the keyboard to reveal the system's mainboard. Locate the 10-pole DIP Switch to set the correct configuration for CPU core frequency (MHz).

Pentium CPU at 3.3V I/O Voltage										
CPU Frequency	1	2	3	4	5	6	7	8	9	10
133 MHz	Off	Off	On	Off	Off	Off	Off	X	X	X
150 MHz	On	Off	On	On	Off	Off	Off	X	X	X
166 MHz	Off	Off	On	On	Off	Off	Off	X	X	X
200 MHz	Off	Off	Off	On	Off	Off	Off	X	X	X
233 MHz	Off	Off	Off	Off	Off	Off	Off	X	X	X

* X = Not Applied.

Pentium CPU at 2.5V I/O Voltage										
CPU Frequency	1	2	3	4	5	6	7	8	9	10
166 MHz	Off	Off	On	On	On	On	Off	X	X	X
200 MHz	Off	Off	Off	On	On	On	Off	X	X	X
233 MHz	Off	Off	Off	Off	On	On	Off	X	X	X
266 MHz	Off	Off	On	On	Off	On	Off	X	X	X

* X = Not Applied.

Flash ROM BIOS

In order to keep up with the latest system BIOS, you may upgrade your Notebook system from available source, your dealer for example. Continue the process that you work with CPU processor's clock. The DIP Switch need to be set **On** when you are going to update the existing system BIOS. But you should set them back **Off** after updating BIOS is complete.

Flash ROM BIOS	1	2	3	4	5	6	7	8	9	10
Existing BIOS	X	X	X	X	X	X	X	X	Off	Off
Updating BIOS	X	X	X	X	X	X	X	X	On	On

* X = Not Applied.

Accessing DIP Switch

1. Turn the system power off.
2. Press the two keyboard latches so that the keyboard can be elevated from its normal position (Figure 2-4).
3. Carefully lift the keyboard assembly out so that the mainboard is exposed. Locate the 10-pole DIP Switch to set the configuration (Figure 2-5).

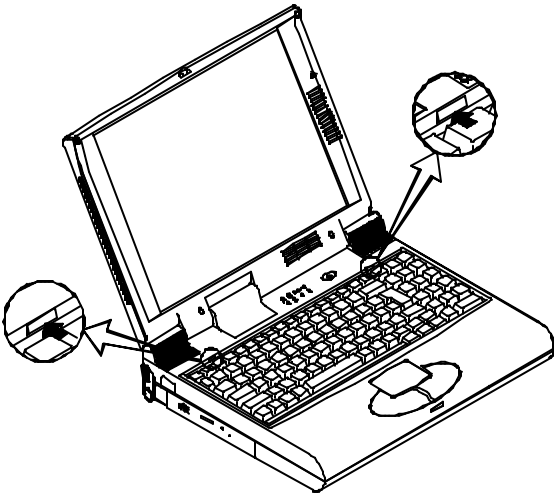

Figure 2-4

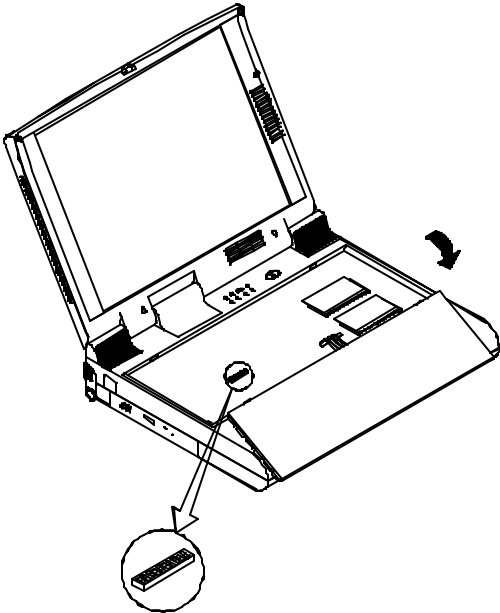

Figure 2-5

CPU Core Voltage

Locate the 8-pole DIP Switch to set the correct configuration for CPU core voltage.

CPU Core Voltage	1	2	3	4	5	6	7	8
1.8 V	On	Off	Off	Off	Off	Off	Off	Off
2.0 V	On	On	Off	Off	Off	Off	Off	Off
2.1 V	On	On	On	Off	Off	Off	Off	Off
2.35 V	On	On	On	On	Off	Off	Off	Off
2.45 V	On	On	On	On	On	Off	Off	Off
2.8 V	On	On	On	On	On	On	Off	Off
2.9 V	On	On	On	On	On	On	On	Off
3.3 V	On	On	On	On	On	On	On	On

Accessing DIP Switch

1. Turn the system power off.
2. Turn the Notebook over.
3. Remove the CPU cover. Locate the 8-pole DIP Switch to set the configuration (Figure 2-6).

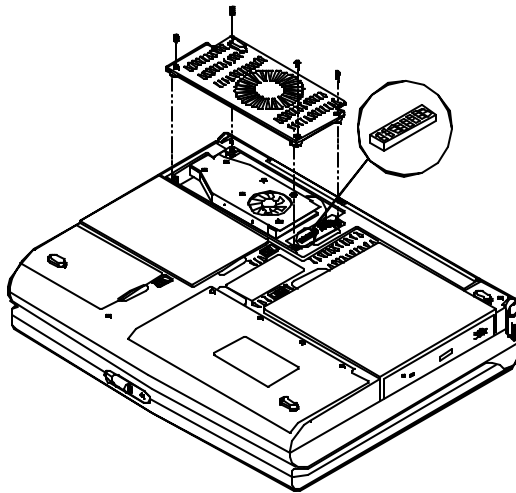

Figure 2-6

Expanding Memory

The system has two memory sockets for different RAM modules to expand the memory up to 128MB. These RAM modules are 144-pin SODIMM (Small Outline Dual In-line Memory Module) type. The Notebook supports Fast Page Mode, EDO, and SDRAM operation. With the following memory configurations, the total memory size will be automatically detected by the POST routines:

Bank 0 (64-bit)	Bank 1 (64-bit)	Power	Speed	Total Size
(1Mx16)x4	None	3.3V	60ns	8MB
(1Mx16)x4	(1Mx16)x4			16MB
(1Mx16)x8	None			16MB
(2Mx8)x8	None			16MB
(1Mx16)x8	(1Mx16)x4			24MB
(4Mx16)x4	None			32MB
(2Mx8)x8	(2Mx8)x8			32MB
(1Mx16)x8	(1Mx16)x8			32MB
(4Mx16)x4	(4Mx16)x4			64MB
(4Mx16)x8	None			64MB
(8Mx8)x8	None			64MB
(4Mx16)x8	(4Mx16)x4			96MB
(4Mx16)x8	(4Mx16)x8			128MB
(8Mx8)x8	(8Mx8)x8			128MB

1. Turn the system power off.
2. Press the two keyboard latches so that the keyboard can be elevated from its normal position (Figure 2-4).
3. Carefully lift the keyboard assembly out so that the mainboard is exposed (Figure 2-8).

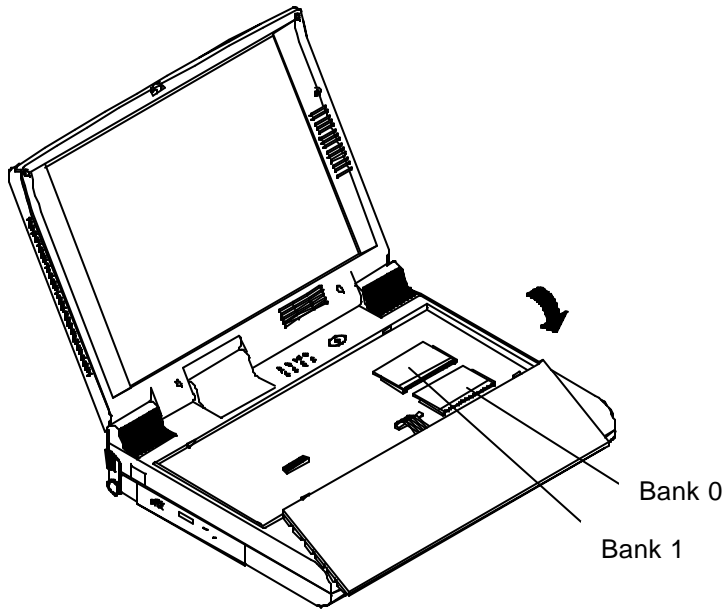

Figure 2-8

Installing Memory Module

Follow the steps below to install the memory module:

1. Turn the system power off.
2. Press the two keyboard latches so that the keyboard can be elevated from its normal position (Figure 2-4).
3. Carefully lift the keyboard assembly out so that the mainboard is exposed. Locate the memory sockets (Figure 2-8).
4. Position the memory module at a slight angle and fit its connectors into the socket firmly. Push the module down and ensure it locks into place (Figure 2-9).
5. Reinstall the keyboard assembly.

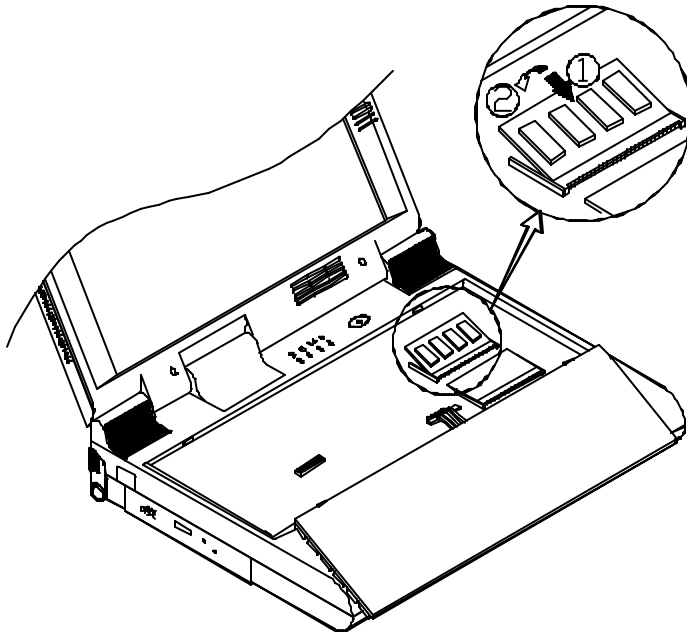

Figure 2-9

Removing Memory Module

1. Turn the system power off.
2. Press the two keyboard latches so that the keyboard can be elevated from its normal position (Figure 2-4).
3. Carefully lift the keyboard assembly out to expose the mainboard. Locate the memory sockets (Figure 2-8).
4. Gently pull outward the two latches on both ends of the module. The module will pop up (Figure 2-10).
5. Remove the memory module.
6. Reinstall the keyboard assembly.

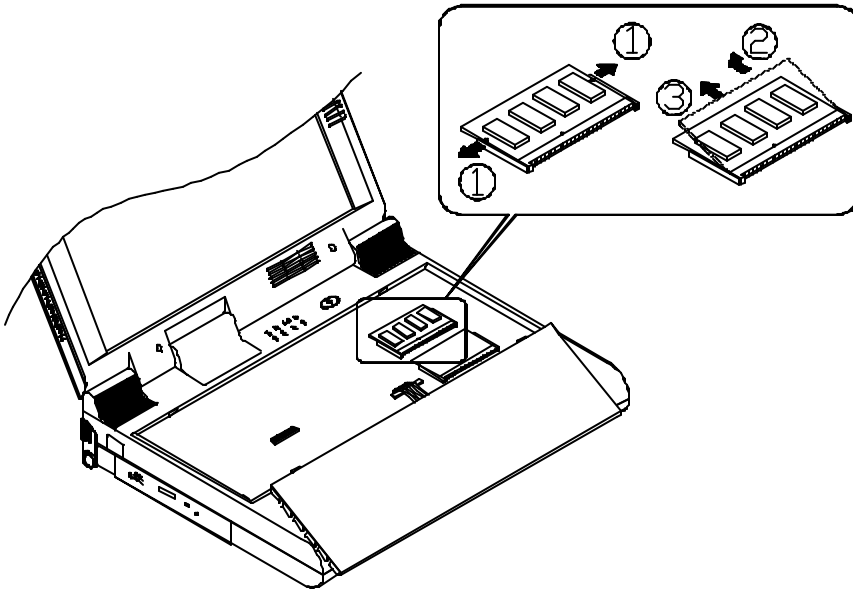

Figure 2-10

Using Hard Disk Drive

The hard disk drive of the Notebook can be removed since it is mounted on a removable case. The case can house any 2.5" IDE hard disk drive with a height of 12.7mm. The system supports drives with capacities greater than 528MB through the Logical Block Addressing (LBA) mode. It also supports Programmed I/O (PIO) mode 4 and provides high performance data transfer rate at speed up to 33 MBytes/second (ATA-33).

Removing

1. Turn the system power off.
2. Turn the Notebook over.
3. Locate the Hard Disk Drive latch.
4. Press the latch in the illustrated direction and slide the hard disk drive out of the Notebook (Figure 2-11).

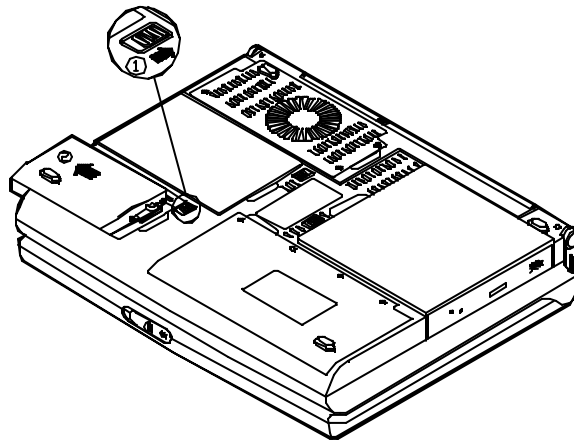

Figure 2-11

Inserting

When inserting the hard disk drive back into the Notebook, be sure to seat the hard disk drive firmly. You will feel the drive click into position when it is seated properly.

Using Floppy Disk Drive

The Notebook comes standard with a 1.44MB, 3.5" floppy disk module. It is labeled drive A: and may be used as a boot device if properly set.

You may replace the floppy disk module with the following options: 2.5" secondary hard disk drive (of 12.7mm high or less), 3.0" secondary hard disk drive (of 12.5mm high or less), or 100MB Zip drive (of 15mm high). Contact your dealer for more details of these options.

Inserting/Removing Diskettes

When using the floppy drive, always insert your floppy diskette label-side up (Figure 2-12). To remove your diskette, press the eject button on the top-right corner of the floppy drive.

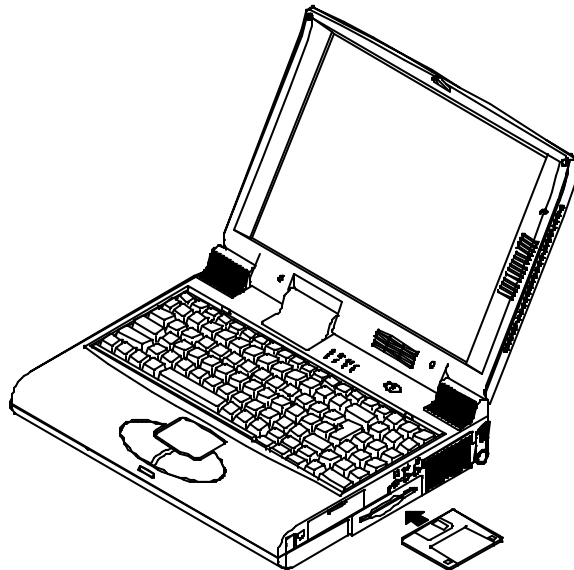

Figure 2-12

Replacing Floppy Disk Drive

1. Turn the system power off.
2. Turn the Notebook over.
3. Locate the Floppy Diskette Drive latch.
4. Press the latch in the illustrated direction and slide the floppy diskette drive out of the Notebook (Figure 2-13).
5. Slide the optional device (2.5"/3.0" secondary HDD or 100MB Zip drive) all the way into the Notebook Computer.

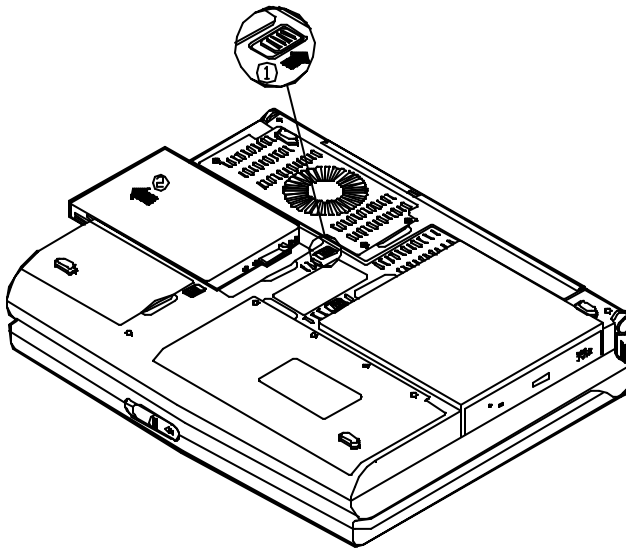

Figure 2-13

Using CD-ROM

The Notebook comes standard with a removable 5.25" CD-ROM module. It is labeled drive D: and may be used as a boot device if properly set.

Do not disassemble the CD-ROM module. Only certified technicians should perform repairs to the CD-ROM module.

To insert a CD, press the **Eject Button** and place the CD on the **Disc Tray** label-side facing up. Push the CD tray in, and you are ready to get started. The **Busy Indicator** will light up while data is accessed or audio is playing. When system power is unexpectedly interrupted, insert an instrument such as a straightened paper clip into the **Emergency Eject Hole** to manually eject the tray (Figure 2-14).

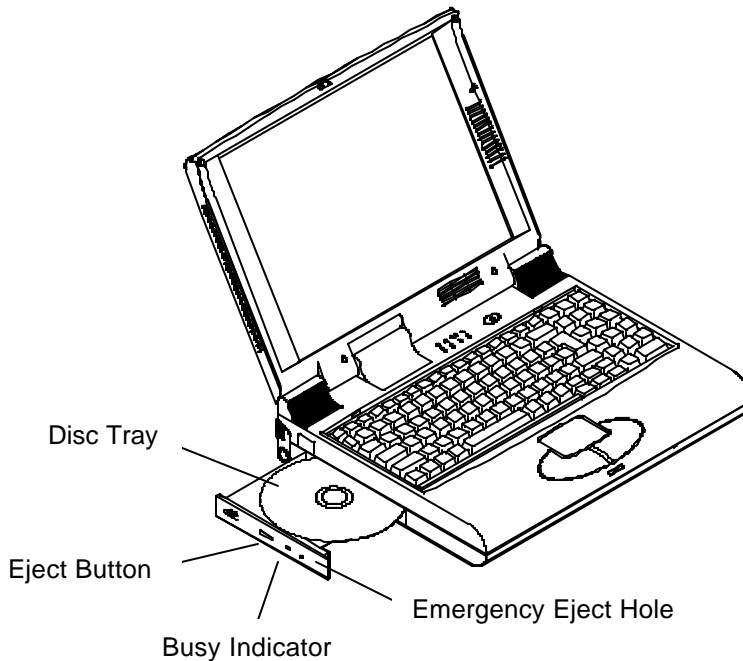

Figure 2-14

Removing CD-ROM Module

1. Turn the system power off.
2. Turn the Notebook over.
3. Locate the CD-ROM latch.
4. Press the latch in the illustrated direction and slide the CD-ROM module out of the Notebook (Figure 2-15).

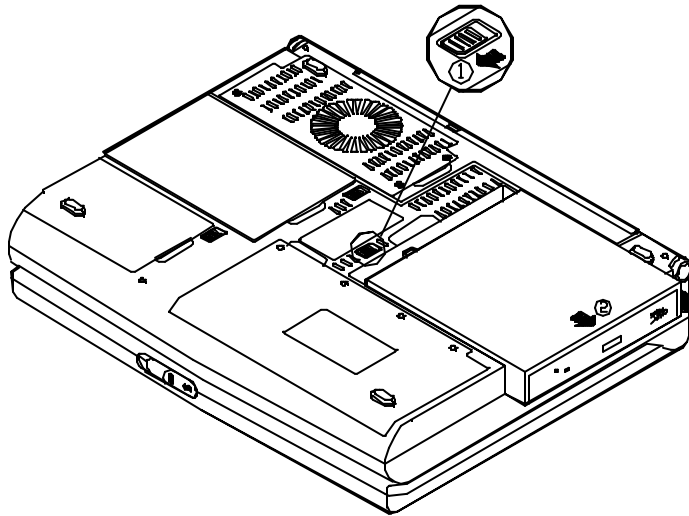

Figure 2-15

Loading Compact Discs

1. Turn on the power.
2. Press the CD-ROM eject button; the disc tray will pop out partially.
3. Pull out the disc tray.
4. Carefully load the CD on the disc tray with label-side facing up. Press it gently to ensure it fits into place (Figure 2-16).
5. Push the tray into the computer to close it.

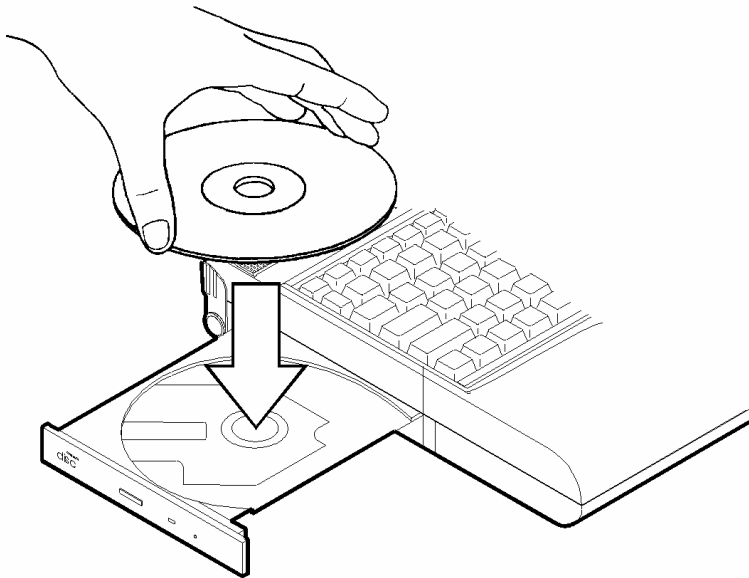

Figure 2-16

Handling of Compact Discs

Proper handling of your CDs will prevent them from being damaged and ensure the accessibility of data stored on them.

- Hold the CD by the edges; do not touch the surface of the disc.
- Use clean, soft, dry cloth to remove dust or fingerprint.
- Do not write on the surface using pen and paste paper.
- Do not store or place the CD in a high temperature place.
- Do not use benzine, thinners, or other cleaners to clean the CD.
- Do not bend the compact disc.
- Do not drop the CDs, or subject them to shock.

Using PC Card Sockets

The Notebook provides system expansion capabilities with two PC card sockets (previously referred to as PCMCIA). PC cards to be inserted can be LAN, fax/modem, communication devices, or expanded memory. Both sockets support 5V/3.3V 16-bit PC cards and 3.3V 32-bit PC cards (referred to as **CardBus**). PC cards have three types: Type I measures 3.3mm thick; Type II 5.0mm; and Type III 10.5mm.

The PC card sockets on the right-side panel support one Type III card (equivalent to two Type II cards) and are **ZV (Zoomed Video)** capable (Figure 2-17).

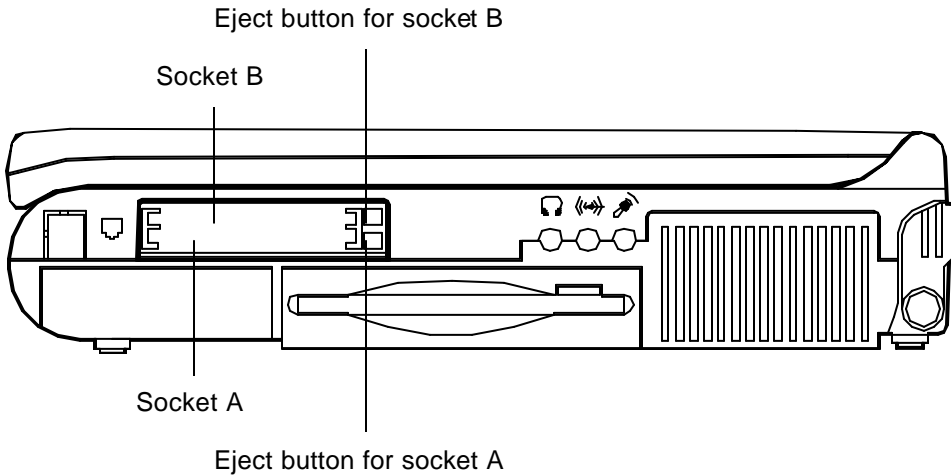

Figure 2-17

Inserting PC Cards

1. Open the access door (Figure 2-18).
2. Align the PC card with the slot and push it in firmly until it locks into place (Figure 2-19).

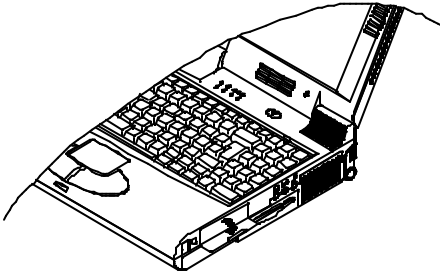

Figure 2-18

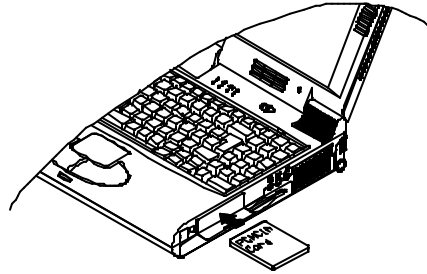























Figure 2-19

Removing PC Cards

To remove a PC card, press the appropriate eject button and the card will be ejected from its slot (please refer to Figure 2-17).

Using Hot Keys

Located on the bottom-left edge of the keyboard layout is a colored **Fn** key. It is a special key only found on the Notebook to make key combination with other keys for easy access to system features. Hold down the **Fn** key while pressing other key as below:

Hot Keys	System Features	Remark
 + 	Expand LCD display	
 + 	Control display top/center position	
 + 	Toggle LCD/LCD+CRT/CRT (+TV) (if a TV is connected)	
 + 	Decrease LCD contrast	Dual scan LCD only
 + 	Increase LCD contrast	Dual scan LCD only
 + 	Decrease LCD brightness	
 + 	Increase LCD brightness	
 + 	Decrease audio volume	
 + 	Increase audio volume	
 + 	Toggle audio mute on/off	
 + 	Put the system in a suspend state for power management	

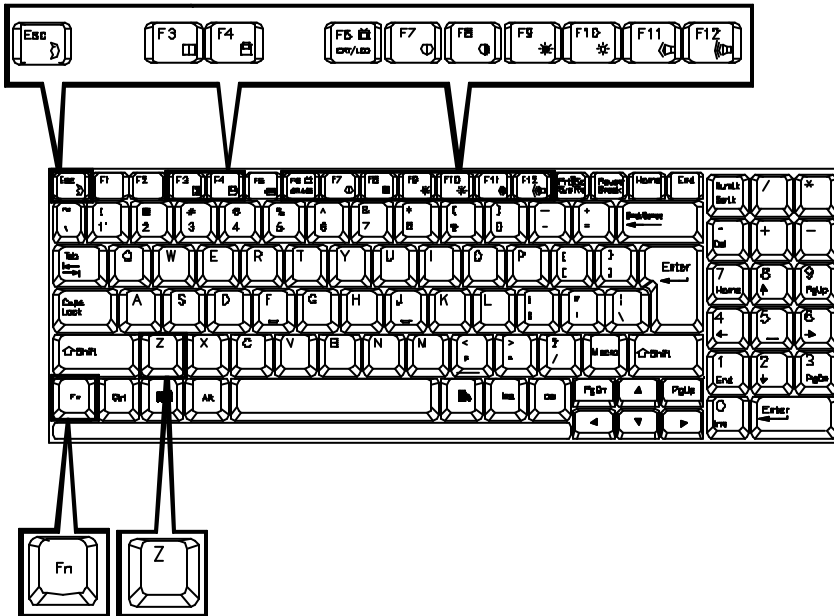

Figure 2-20

Using Numeric Keypad

The Notebook features a 102-key keyboard with the Numeric Keypad integrated for easy numeric data input (Figure 2-21).

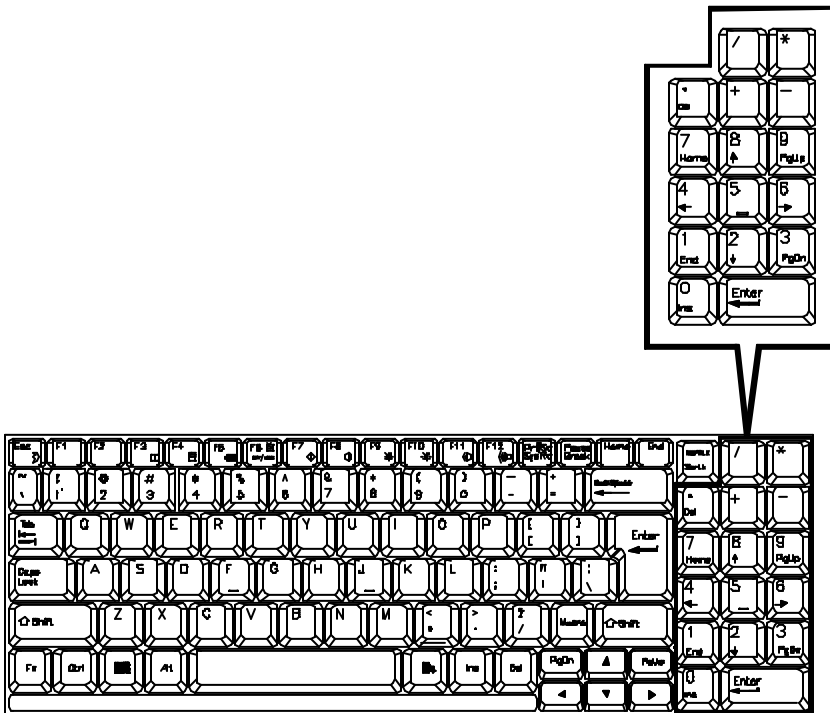
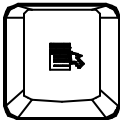

Figure 2-21

Windows 95 Special Keys

Application Key



When the user presses the unmodified Application key, the application brings up the Context menu (a pop-up menu) at the current selection, much as pressing the right mouse button does in some applications today. Pressing the Application key does not disturb the current cursor position.

For compatibility with 101-key keyboards, the functionality of the Application key should map to existing keys – for example, the key combination SHIFT+F10 could map to the Application key functionality.

Windows Key

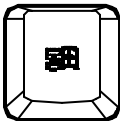

When the user presses the Windows key, the Start menu appears. It can be used to modify other keys.

The operating system controls the functionality of the Windows key. Only shell applications should implement the key, and then only in such a way as to preserve and extend the key's functionality in the Windows 95 shell.

TV Output

The Notebook is equipped to output video signals to a TV set through the S-video jack. Different countries use different TV broadcast standards. A TV set must comply with the appropriate standard to properly receive broadcast signals. In the United States, TV sets are built to comply with the NTSC standard. Many countries in Europe and Asia use the PAL standard. You should refer to your TV user guide to make sure which TV standard you are using and enter the System Configuration Utility (SCU) to specify the proper TV mode (please refer to Chapter 3: BIOS Utilities, Components Menu for more information).

TV-output capabilities allow display of realistic game, video, and multimedia on the large-screen TV. The Notebook uses hardware filtering technologies to reduce flicker for qualified presentation.

LCD Panel

The Notebook Computer features the LCD panel display with the followings:

- PCI local bus controller.
- 4MB video RAM (EDO type).
- Capability to support 1024x768 (XGA) resolution DSTN/TFT display.
- Ability to output the video to other video display device:
 - VGA monitor (CRT).
 - TV set.
- VPM (Video Port Manager) provider, the driver-level software, to gain direct control of the display hardware for video input from:
 - ZV-capable PC card.

Remark:

Two technologies of LCD display:

- Passive technology (DSTN = Dual-scan Super Twisted Nematic).
- Active technology (TFT = Thin Film Transistor).

Using Power Management

The Notebook system provides you with various modes to manage its power consumption while maintaining system performance. Please refer to Chapter 3: BIOS Utilities, System Configuration Utility, Power Menu for more information.

Advanced Power Management (APM 1.2)

The Notebook provides built-in Advanced Power Management (APM 1.2) support to reduce power consumption. The functionality of APM varies depending on the operating system you are using. **Some operating systems do not support APM, such as Windows NT, and therefore, cannot take advantage of the system's capabilities in this area.**

Advanced Configuration and Power Interface (ACPI)

The ACPI interface gives the operating system (OS) direct control over the power management and Plug and Play functions of a computer. The operating system can perform the functions covered by the ACPI specification, such as system power management, device power management, thermal management.

Global Standby

Under Global Standby mode, the CPU clock will be stopped and most controllable peripheral devices will be powered off. If the idle timer expires before any system activity is detected, the system will transition Standby mode into Suspend mode.

Suspend and Resume

The system offers the ability to halt operations at extremely low power yet retain all its programming, called **Suspend**. The Suspend Mode features three levels: Powered-On-Suspend (POS) mode, Suspend-To-RAM (STR) mode, and Suspend-To-Disk (STD) mode.

Be sure not to initialize the Suspend Mode when any of the disk drives is accessed such as HDD, FDD and CD-ROM drive.

The system operation can be returned from exactly where it was suspended when wake-up events occur, called **Resume**.

Powered On Suspend (POS)

Powered-On-Suspend mode saves the minimum power among the three suspend modes. However, it takes the shortest time to return to full operation.

Resume from POS Mode

The system may be resumed from Powered-On-Suspend mode by:

- Alarm resume (month/day/hour/minute)
- Modem ring
- Any keyboard key pressed
- Power button pressed (if configured as Suspend/Resume function under SCU)
- Opening the display lid (only if the suspend event is initialized by closing the display lid)

Suspend To RAM (STR)

Suspend-To-RAM mode is the medium level of system power management.

Resume from STR Mode

The system may be resumed from Suspend-To RAM mode by:

- Alarm resume (month/day/hour/minute)
- Modem ring
- Power button pressed (if configured as Suspend/Resume function under SCU)
- Opening the display lid (only if the suspend event is initialized by closing the display lid)

Suspend To Disk (STD)

Suspend to Disk is a 0-volt suspend mode for system power management. STD mode saves the maximum power but takes the longest time to return to full operation.

1. Use your operating system's FDISK program to delete all partitions of the hard disk if any already exists on the target drive.
2. Boot the system from the A: drive and run the 0VMAKFIL.EXE Utility to create the Suspend to Disk partition on the hard disk whose size will accommodate **the installed DRAM (n) plus 4MB integrated video RAM.**

A:\>0VMAKFIL /Pn

For example, if the system DRAM is 32MB, 0VMAKFIL will create a partiton of size about 36MB.

A:\>0VMAKFIL /P32

Note: Rewrite the sector signatures if you need to partition again the very hard disk.

C:\>0VMAKFIL /PW

3. Re-partition the hard disk using your operating system's FDISK program.

Resume from STD Mode

The system may be resumed from Suspend-To-Disk mode by:

- Power back on
- Alarm resume (month/day/hour/minute)
- Opening the display lid (only if the suspend event is initialized by closing the display lid)

Chapter 3: BIOS Utilities

This chapter provides you information of Power On Self Test (POST) and shows you how to configure the system parameters through the System Configuration Utility (SCU).

Power On Self Test (POST)	3-2
POST Message: Normal Operation.....	3-2
POST Message: Error Detected	3-3
System Configuration Utility (SCU)	3-4
Information in the SCU	3-4
Invoking the SCU	3-5
Working with the Menu Bar of the SCU	3-6
Working with the Pull-down Menu of the SCU.....	3-7
Features of the SCU	3-8
Startup Menu.....	3-8
Memory Menu	3-10
Disks Menu.....	3-11
Components Menu.....	3-13
Power Menu	3-16
Exit Menu.....	3-19

Power On Self Test (POST)

The system BIOS (Basic Input/Output System) performs a series of Power On Self Test (POST) on system memory and key computer components every time the computer is powered on. If an error exists, the POST routine may halt execution (depending on the severity of the problem). POST also initializes BIOS configuration then boots the operating system.

POST Message: Normal Operation

If no error occurs, the system will be operated after the POST process is completed.

You may press *Spacebar* key to skip the memory test.

SystemSoft BIOS for Intel 430TX Version 1.01 (2482-00)
Copyright 1983-1996 SystemSoft Corp. All Rights Reserved

166 MHz Pentium CPU
External Cache: 256KB Enabled
4 MB Video RAM

Base Memory	000640 Kb
Extended Memory	031744 Kb
Total Memory	032768 Kb

Auto Detecting IDE Devices[Done]

<CTRL-ALT-S> to enter System Configuration Utility

POST Message: Error Detected

If an error is detected, a WARNING message will be displayed. You should either press **F1** key to continue, or press **Ctrl-Alt-S** key combination simultaneously to enter the System Configuration Utility.

SystemSoft BIOS for Intel 430TX Version 1.01 (2482-00)
Copyright 1983-1996 SystemSoft Corp. All Rights Reserved

166 MHz Pentium CPU
External Cache: 256KB Enabled
4 MB Video RAM

Base Memory	000640 Kb
Extended Memory	031744 Kb
Total Memory	032768 Kb

WARNING – HARD DISK CONTROLLER 1 FAILURE
Auto Detecting IDE Devices[Done]

<CTRL-ALT-S> to enter System Configuration Utility
Press F1 to Continue

System Configuration Utility

The System Configuration Utility (SCU) is a ROM-based configuration utility that displays the system's configuration status and provides users with a tool to set their system parameters. The settings are stored in non-volatile battery-backed CMOS RAM which saves the information even when the power is turned off, and retains that when the system is turned back on.

Information in the System Configuration Utility

Below shows the system settings that may be changed within the System Configuration Utility.

Menu Bar Items	Pull-down Menu Items
Startup	Date and Time, Fast Boot, Boot Device, Display, Enable Battery Low Beep, Enable LCD Expand Mode, Enable Power On Sound, Boot Password, SCU Password.
Memory	Cache Systems.
Disks	Diskette Drives, IDE Settings.
Components	COM Ports, LPT Port, PS/2 Mouse Port, Microsoft IntelliMouse Support, Keyboard Numlock, Keyboard Repeat, Audio Device, TV Mode.
Power	Enable Power Saving, Low Power Saving, Medium Power Saving, High Power Saving, Customize, Suspend Controls, Resume Timer, Advance CPU Controls.
Exit	Save and Exit, Exit (No Save), Default Settings, Restore Settings, Version Info.

Invoking the System Configuration Utility

The System Configuration Utility (SCU) will be accessed when simultaneously press the **Ctrl**, **Alt**, and **S** keys.

<CTRL-ALT-S> to enter System Configuration Utility

The above message only lasts seconds. If you miss it, the computer will access its boot process. You must reboot the system and try again within the time limit if you want to enter the System Configuration Utility.

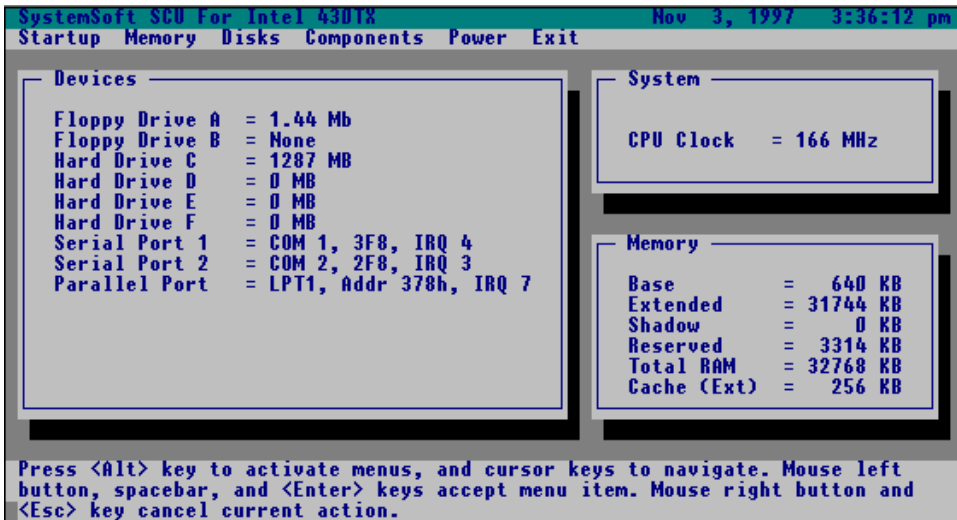

Figure 3-1
System Configuration Utility (SCU)

Working with the Menu Bar of the System Configuration Utility

Press simultaneously the **Ctrl-Alt-S** key combination to enter the menu bar of the System Configuration Utility.

Action	Keys Used	Description
Activate menus	Alt	Activate the System Configuration Utility.
Select menu bar item	Left arrow (←)	Move to a menu bar item on the left.
	Right arrow (→)	Move to a menu bar item on the right.
	The highlighted letter key	Move to the correspondent menu bar item.
Accept menu bar item	Mouse left button Spacebar Enter	Enter the selected menu bar item to configure settings.
Cancel current action	Mouse right button Esc	Undo the current command.

Working with the Pull-down Menu of the System Configuration Utility

When the desired menu bar item is highlighted, press the **Enter** key to enter the pull-down menu for values setting.

Action	Keys Used	Description
Select pull-down menu item	Down arrow (↓)	Move to the next pull-down menu item.
	Up arrow (↑)	Move to the previous pull-down menu item.
	The highlighted letter key	Move to the correspondent pull-down menu item.
Select a control	Tab	Move between the options.
Change values	Down/Up arrows (↓)(↑)	Modify the settings.
Accept entries	Spacebar	Enable/disable the specified function. When a check mark (√) appears, the function is on.
	Enter	Choose <OK> from a list of options.
Reject entries	Esc	Undo the current setting.
	Enter	Choose <Cancel> from a list of options.
Activate accelerators	Alt	Invoke all the highlighted letters corresponding to their respective options.
Quit	Esc	Press the Esc key to close the pull-down menu.

Features of the System Configuration Utility

Startup Menu

Item	Setting/Option	Function
Date and Time	Day/Month/Year Hour/Minute/Second	Set the current date and time.
Fast Boot	Enable	Initialize and quickly boot the system in a few seconds by skipping certain diagnostic tests.
	Disable	Disable the above.
Boot Device	Diskette A	Specify where the system boots from.
	Hard Disk C	
	CD-ROM Drive	
Display	CRT (+ TV)	Activate the CRT or both CRT and TV if a TV is connected.
	LCD	Activate the system's LCD panel.
	LCD+CRT	Activate both the LCD and CRT.
Enable Battery Low Beep	Enable	The system emits a series of warning beep sound when battery power becomes low.
	Disable	Disable the above.
Enable LCD Expand Mode	Enable	Stretch the display to fill the entire viewing area of the LCD panel.
	Disable	Disable the above.
Enable Power On Sound	Enable	Enable/Disable power on sound playback.
	Disable	
Boot Password	Enter old Power-On Password	Set password for booting computer. Users are authorized to start the system after entering correct password.
	Enter new Power-On Password	
	Verify new Power-On Password	
	Enable Password to Power-On	

Item	Setting/Option	Function
SCU Password	Enter old Setup Password	Set password for modifying SCU. Users are authorized to change the SCU setting after entering correct password.
	Enter new Setup Password	
	Verify new Setup Password	
	Enable Setup Password	

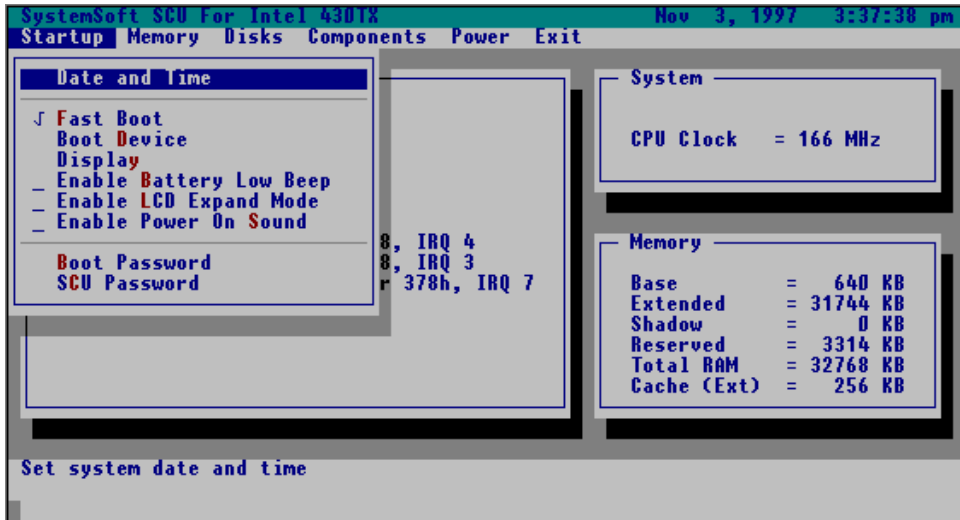

Figure 3-2
Startup Menu

Memory Menu

Item	Setting/Option		Function
Cache Systems	L1 Cache	Disabled	Disable the processor's internal cache.
		Write Back	Enable the processor's internal write-back cache.
	L2 Cache	Disabled	Disable the L2 cache controller.
		Write Back	Enable the L2 write-back cache.

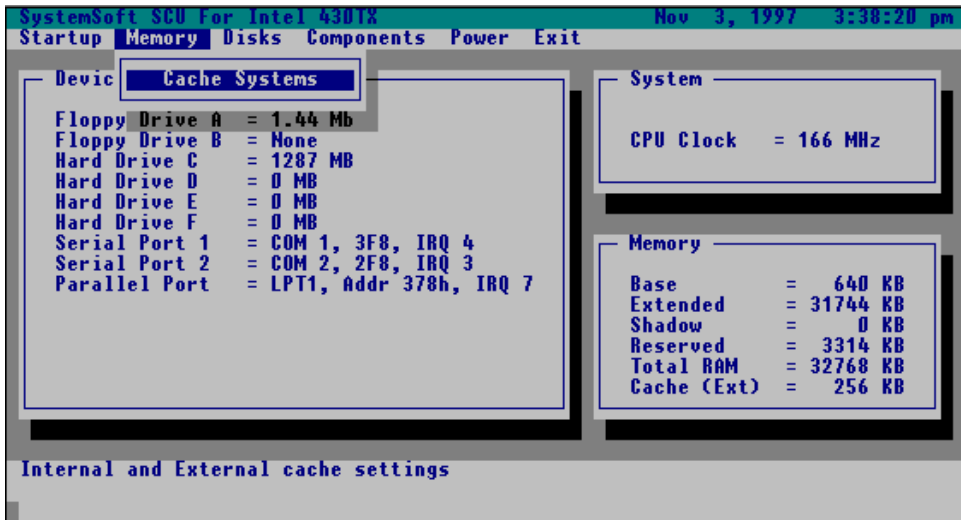

Figure 3-3
Memory Menu

Disks Menu

Item	Setting/Option		Function
Diskette Drives	Drive A	None	Specify the drive types for the diskette drive A and B.
		1.2 MB	
		720 KB	
		1.44 MB	
		2.88 MB	
	Drive B	None	
		1.2 MB	
		720 KB	
		1.44 MB	
		2.88 MB	
IDE Settings	Primary HDD	Drive Enabled	Enable enhanced IDE settings. (When CD-ROM is selected as boot device, remember to enable CD-ROM drive.)
		PIO Mode	
	CD-ROM	Drive Enabled	
		PIO Mode	
	Secondary IDE	Drive Enabled	
		PIO Mode	

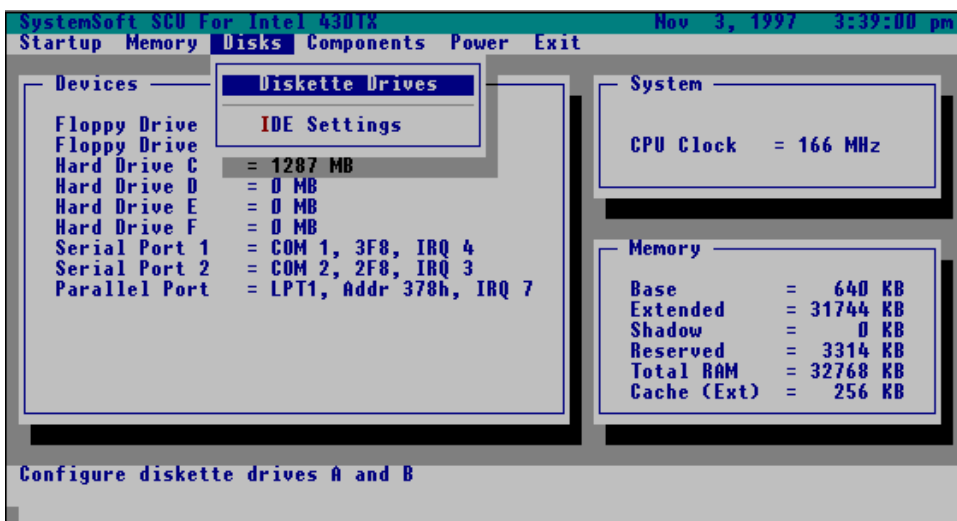

Figure 3-4
Disks Menu

Components Menu

Item	Setting/Option	Function	
COM Ports	COM A I/O Settings	None	Specify the COM A configuration.
		COM1, 3F8, IRQ4	
		COM2, 2F8, IRQ3	
		COM3, 3E8, IRQ4	
		COM4, 2E8, IRQ3	
	COM B I/O Settings	None	Specify the COM B configuration.
		COM1, 3F8, IRQ4	
		COM2, 2F8, IRQ3	
		COM3, 3E8, IRQ4	
		COM4, 2E8, IRQ3	
	Mode Setting For COM B	Normal (16550A)	Define the COM B hardware.
		IrDA (HPSIR)	
		ASK IR	
FAST IR			
DMA Setting For Fast IR	DMA 0	Specify the Fast IR DMA configuration.	
	DMA 1		
	DMA 3		
LPT Port	Port Address	None	Specify the LPT port and IRQ configuration.
		LPT1, Addr 378h, IRQ7	
		LPT2, Addr 278h, IRQ5	
		LPT3, Addr 3BCh, IRQ7	
	Port Definition	Standard AT (Centronics)	
		Bidirectional (PS-2)	
		Enhanced Parallel (EPP)	
		Extended Capabilities (ECP)	
	DMA Setting For ECP Mode	DMA 1	Specify the ECP DMA configuration.
		DMA 3	
	EPP Type	EPP 1.7	Specify the EPP type.
EPP 1.9			

Item	Setting/Option		Function
PS/2 Mouse Port	Enable		Enable the system's trackpad or an external PS/2 mouse.
	Disable		Disable the trackpad or PS/2 mouse if an external mouse is connected to COM A port.
Microsoft IntelliMouse Support	Enable		Enable/Disable Microsoft IntelliMouse support.
	Disable		
Keyboard Numlock	Enable		Specify whether Num Lock is on or off at system boot time.
	Disable		
Keyboard Repeat	Key Repeat Rate	2 cps	Define the rate (character per second) at which the keyboard repeats while a key is depressed.
		6 cps	
		10 cps	
		15 cps	
		20 cps	
		30 cps	
	Key Delay	¼ sec	Specify the amount of time (second) that will pass after a key is depressed before the key starts to repeat.
		½ sec	
¾ sec			
1 sec			
Audio Device	Audio Device	Disable	Enable/Disable the audio device.
		Enable	
	Audio Port Addresses	At 220h-22Fh	Specify the audio port address.
		At 240h-24Fh	
		At 260h-26Fh	
		At 280h-28Fh	
	MIDI Port Addresses	At 300h-303h	Specify the MIDI port address.
		At 330h-333h	
	Audio, MIDI IRQ	IRQ 5	Specify the IRQ configuration for audio or MIDI port.
		IRQ 7	
		IRQ 9	
		IRQ 10	
Playback DMA	DMA 0	Specify the DMA channels for audio playback.	
	DMA 1		
Record DMA	DMA 1	Specify the DMA channels for audio recording.	
	DMA 3		

Item	Setting/Option		Function
TV Mode	TV Encoder	Disable	Enable/Disable the TV encoder.
		Enable	
	TV Modes Selection	PAL 800x600 Underscan	Specify the TV mode as NTSC or PAL.
		PAL 640x480 Underscan	
		NTSC 640x480 Overscan	
		NTSC 640x480 Underscan	
		PAL 640x480 Overscan	
		PAL 800x600 Overscan	
	NTSC 800x600 Underscan		

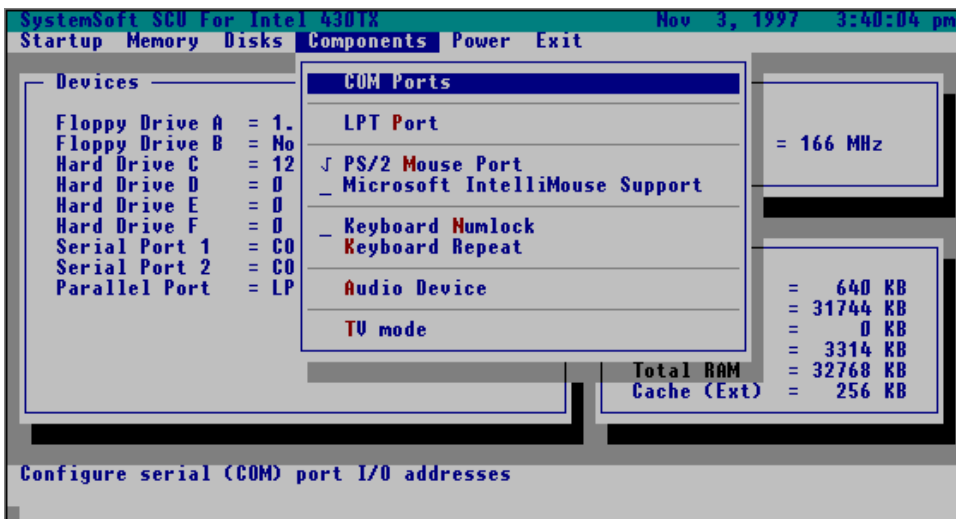

Figure 3-5
Components Menu

Power Menu

Item	Setting/Option		Function
Enable Power Saving	Enable		Enable/Disable all power saving features.
	Disable		
Low Power Saving	Enable		Enable/Disable the power saving to its lowest which results in max. performance but shortest battery life.
	Disable		
Medium Power Saving	Enable		Enable/Disable the power saving to its medium which results in both moderate performance and battery life.
	Disable		
High Power Saving	Enable		Enable/Disable the power saving to its highest which results in min. performance but longest battery life.
	Disable		
Customize	Disk Standby	Always on	The hard disk will be put on standby if it is not accessed within the specified period. Hard disk power will be restored when the disk drive is accessed again.
		30 sec	
		1 min	
		1.5 min	
		2 min	
	Global Standby	Always on	The system power will be reduced if the system has been idled for the specified period. System power will be restored when any system activity is detected.
		1 min	
		2 min	
		4 min	
		6 min	
		8 min	
		12 min	
		16 min	

Item	Setting/Option		Function
Suspend Controls	Power Button Function	Power On/Off	The power button is toggled to turn the system on or to turn it off.
		Suspend/Resume	The power button acts as a suspend/resume button for transitioning the system between a working state and the suspend mode.
			Pressing the power button for more than four seconds will generate a power button over-ride event to transition the system from a working state to the Soft-Off state.
	Lid Switch Function	Suspend/Resume	Enter suspend mode or resume by closing or opening the display lid.
		LCD Panel Off/On	Turn the panel power on or off by opening or closing the display lid.
	Suspend Type	Suspend To Disk	Specify the suspend mode for power management.
		Suspend To RAM	
		Powered On Suspend	
	Suspend Timeout	Never	If the system has been idled for the specified period, the system will enter user-defined suspend.
		1 min	
5 min			
10 min			
20 min			
	30 min		
Resume Timer	Alarm Resume	Enable	Resume the system from the configured suspend mode when resume alarm timer expires.
		Disable	
	Resume Month/Day/Hour/Minute		The system will resume at the specified time (month, day, hour and minute).

Item	Setting/Option		Function
Advance CPU Controls	Clock Control	Full Speed	Specify the type of Processor Clock Control.
	Mechanism	Doze Mode	

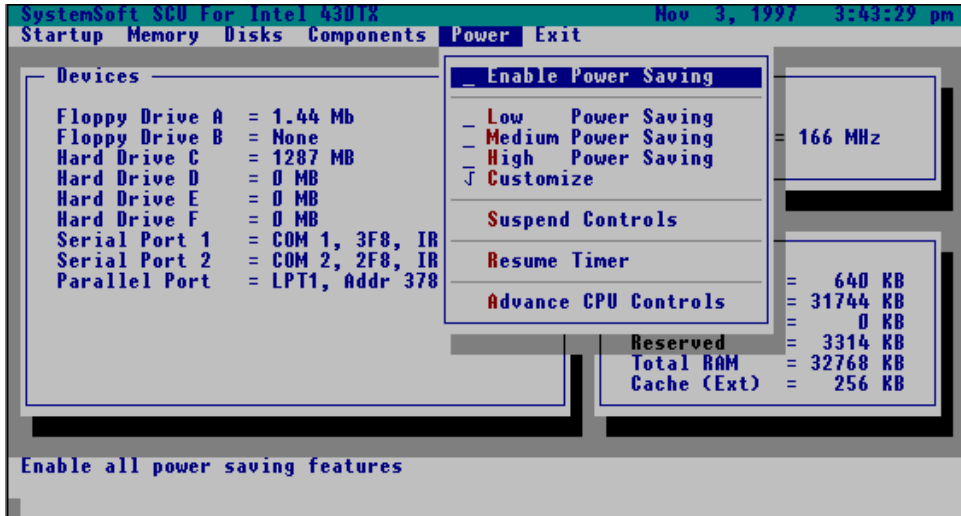

Figure 3-6
Power Menu

Exit Menu

Item	Function
Save and Exit	Save the current settings and reboot the system.
Exit (No Save)	Exit without saving any current changes.
Default Settings	Restore the default settings (the original ones found in ROM).
Restore Settings	Restore the current setup settings to the original custom ones.
Version Info	Show current BIOS version information.

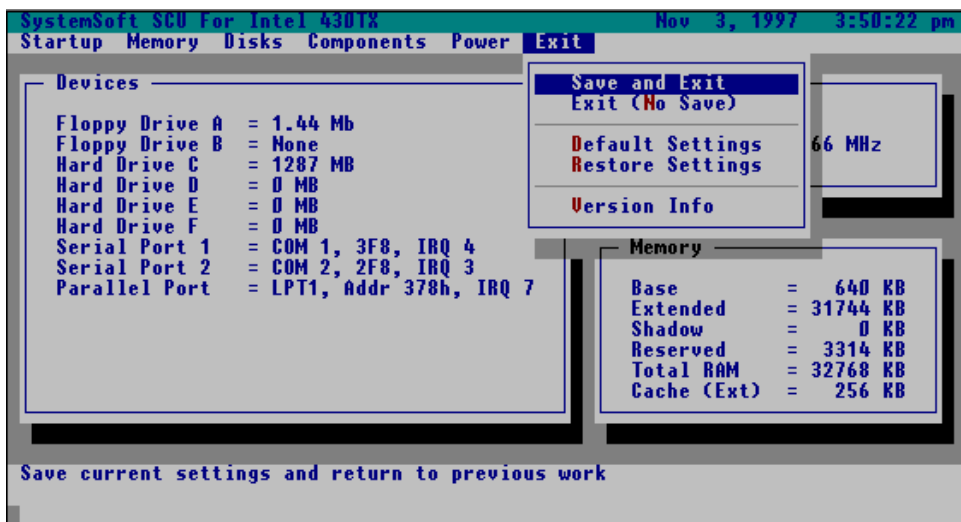

Figure 3-7
Exit Menu

Chapter 4: Peripheral Devices

This chapter shows you how to attach peripheral devices to the ports or jacks on the rear panel of the Notebook Computer.

Attaching a Security Lock	4-2
Attaching a Parallel Printer	4-3
Attaching a TV Set	4-4
Attaching a Video Input Device	4-5
Attaching a USB-compatible Device	4-6
Attaching a Serial Mouse	4-7
Attaching an External Monitor (CRT)	4-8
Attaching a PS/2 Keyboard or Mouse	4-9

Attaching a Security Lock

To protect your Notebook from being stolen, the computer is implemented with a security connector. To install the security lock, wrap the cable around the desk or other immovable object. Then, insert the locking device into this security connector (Figure 4-1).

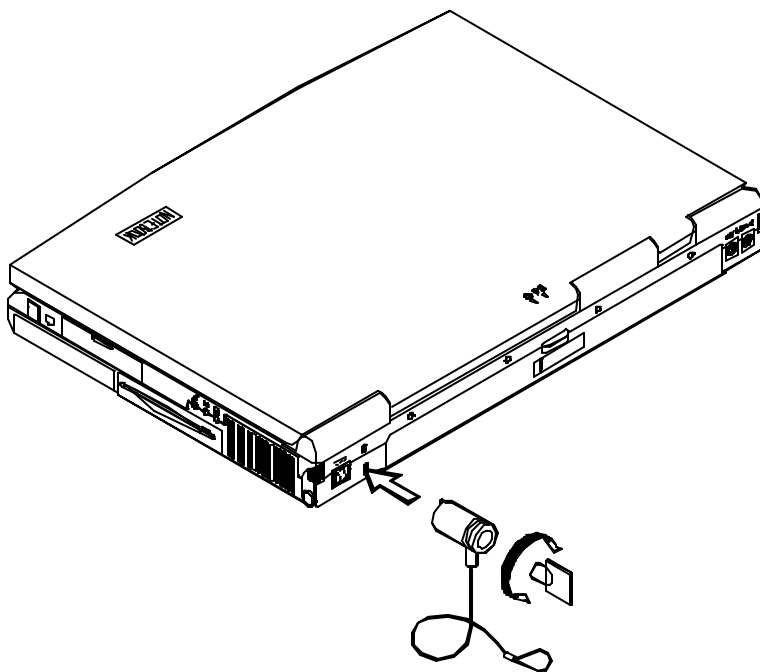

Figure 4-1

Attaching a Parallel Printer

You may connect any standard Centronics parallel printer to your Notebook through the parallel port.

1. Turn the system power off.
2. Connect the cable to the parallel port on the rear of the Notebook Computer.
3. Tighten the screws that fasten the cable to the parallel port (Figure 4-2).
4. Insert the other end of the cable to the printer's connector. Fasten the cable's connector.
5. Turn on the printer and Notebook Computer.

In addition, you will need to install the manufacturer-supplied driver for the printer. Refer to the device's user's guide for more information. If the connected printer supports EPP (Enhanced Parallel Port) or ECP (Extended Capabilities Port) mode, please enter System Configuration Utility (SCU) to configure the required setting.

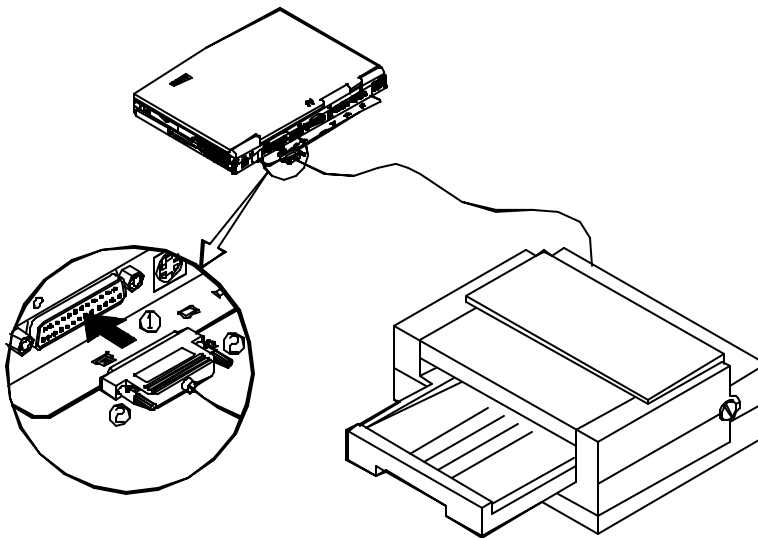

Figure 4-2

Attaching a TV Set

The S-video jack on the rear panel of the Notebook is used for transmitting video signal to a TV set. You may need to select the video standard for video display. Enter the System Configuration Utility (SCU), Components Menu to specify the appropriate TV mode. Simultaneous display on external monitor (CRT) and TV is available. You may enter the SCU to select the appropriate parameters or toggle **Fn + F6** keys (refer to Chapter 2, Using Hot Keys).

Attach the TV set as shown below (Figure 4-3).

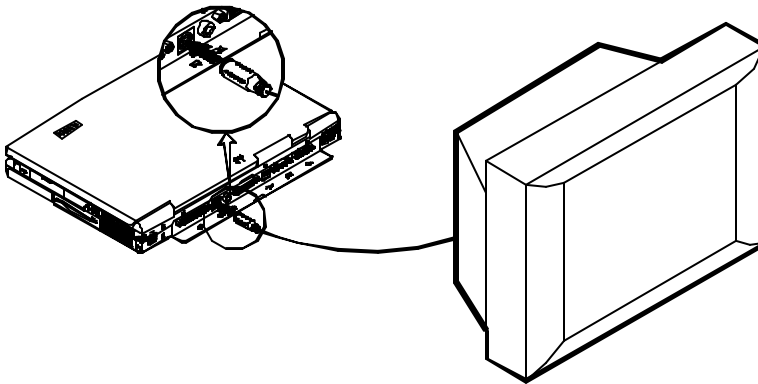

Figure 4-3

Attaching a Video Input Device

The RCA jack on the rear panel of the Notebook allows analog composite signals to input from external video devices. Attach the device as shown below (Figure 4-4).

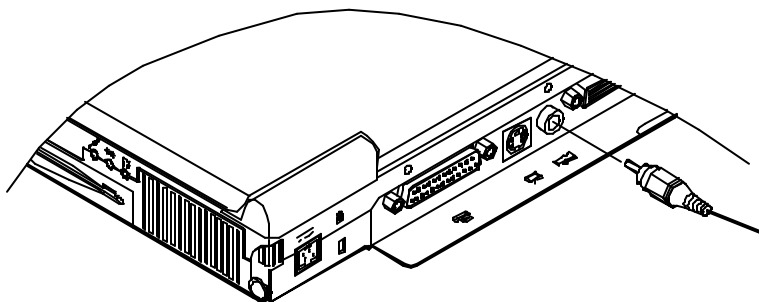

Figure 4-4

Attaching a USB-compatible Device

The Notebook implements dual USB ports for connection of USB-compatible keyboard, mouse or other devices. Attach the device as shown below (Figure 4-5).

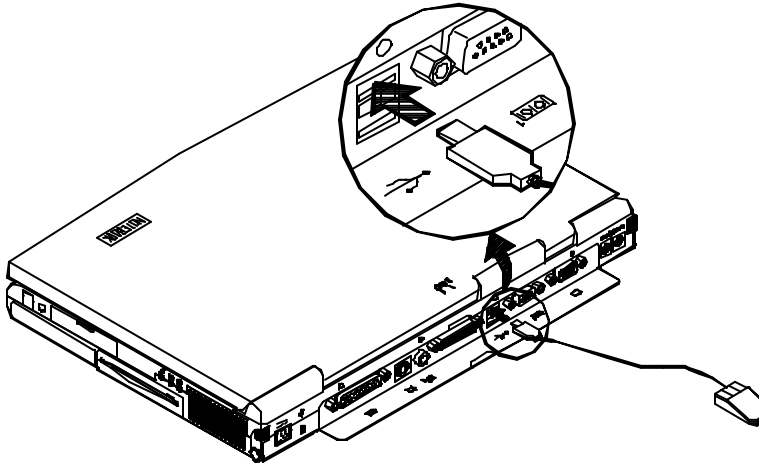

Figure 4-5

Attaching a Serial Mouse

The serial port features a 9-pin connector. You can connect any serial device such as a serial mouse to this port.

1. Turn the system power off.
2. Connect the cable to the serial port on the rear of the Notebook Computer.
3. Tighten the screws that fasten the cable to the serial port (Figure 4-6).
4. Turn on the Notebook Computer.

In addition, you may need to install the manufacturer-supplied driver for the serial mouse. Refer to the device's user's guide for more information.

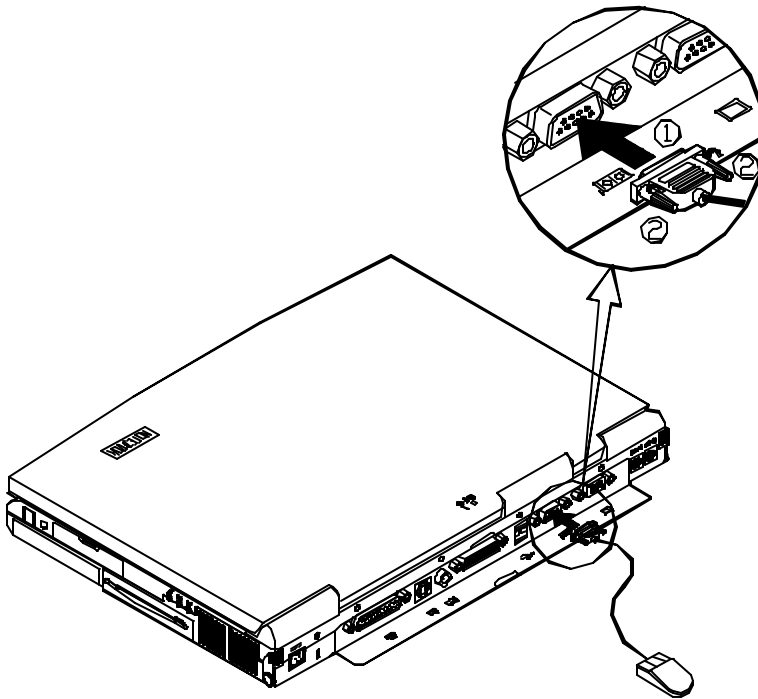

Figure 4-6

Attaching an External Monitor (CRT)

The computer is capable of displaying information not only on the LCD, but also on XGA compatible displays that are externally attached to the computer. Information can be displayed on both the LCD and the external monitor simultaneously. Enter the System Configuration Utility (SCU) to select the appropriate parameters or toggle **Fn + F6** keys (refer to Chapter 2, Using Hot Keys).

1. Turn the system power off.
2. Connect the cable to the CRT port on the rear of the Notebook Computer.
3. Tighten the screws that fasten the cable to the CRT port (Figure 4-7).
4. Insert the other end of the cable to the external monitor.
5. Turn on the Notebook Computer.

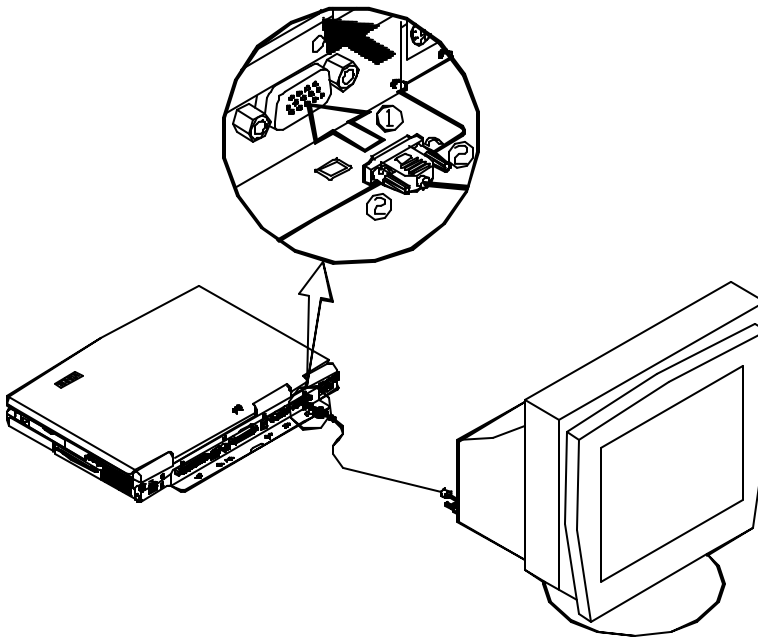

Figure 4-7

Attaching a PS/2 Keyboard or Mouse

The Notebook can be operated with a PS/2 keyboard or mouse that is externally attached by means of the PS/2 transfer cable. Attach the external keyboard or mouse as shown below (Figure 4-8).

Both PS/2 type ports on the rear panel of the Notebook can be used for the connection of PS/2 keyboard and mouse.

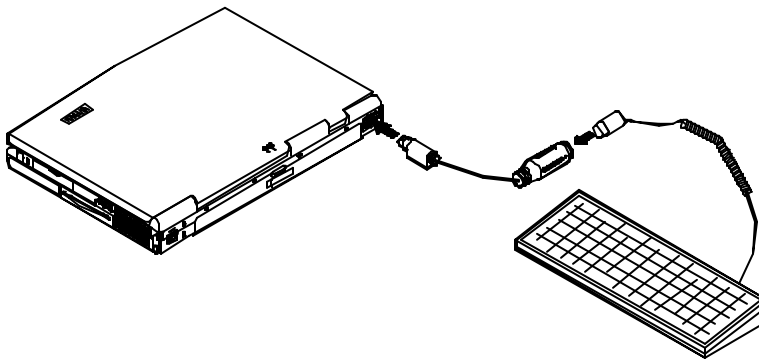

Figure 4-8

Appendix A: Specifications

This appendix describes the features and specifications for the Notebook Computer.

CPU

- Intel P54C/LM.
- Intel P55C/LM with MMX technology.

Memory

- 3.3V power supply.
- Supports Fast Page Mode/EDO/SDRAM.
- 512KB secondary cache Pipeline Burst Synchronous RAM (PBSRAM).
- 8MB expandable up to 128MB.
- *8/16/32/64MB 144-pin SODIMM RAM modules (option).*
**(The x4 bit DRAM chips are not supported.)*

System BIOS

- 256KB flash ROM.
- PCI 2.1.
- Plug and Play 1.0a.

Display

- 15.1" TFT XGA (1024x768 pixels) LCD panel available.
- 13.8" DSTN XGA (1024x768 pixels) LCD panel available.
- 4MB display memory (EDO).
- Video Port Manager (VPM 1.10) for Zoomed Video (ZV) port.
- Simultaneous display with an external monitor.

Mass Storage

- 3.5" floppy diskette drive (interchangeable).
- 2.5" hard disk drive (12.7mm high or less).
- 5.25" CD-ROM.
- *2.5" (12.7mm high or less) or 3.0" (12.5mm high or less) secondary hard disk drive (option).*
- *100MB Zip drive (15mm high) (option).*

 **Audio**

- Sound Blaster Pro compatible.
- 3D stereo sound effects.
- Stereo full duplex support.
- 1MB ROM wavetable.
- Built-in microphone.
- Built-in speakers.

 **PC Card Sockets**

- CardBus support.
- ZV (Zoomed Video) port support.
- Two Type II PC cards or one Type III PC card.

 **Input/Output**

- Built-in trackpad (PS/2).
- Dual USB ports.
- S-video jack for TV output.
- 120-pin expansion port.
- RCA jack for video input.
- External monitor (CRT) port.
- Serial port.
- Parallel port.
- Dual PS/2 type ports.
- Speaker-out jack.
- Line-in jack.
- Microphone-in jack.

 **Infrared Wireless Communication**

- IrDA (HPSIR).
- ASKIR.
- Fast IR.

 **Power Management**

- APM 1.2.
- ACPI.
- Global standby.
- Suspend and resume.

 **AC Power Supply**

- AC input: 100~240VAC, 47~63Hz.
- DC output: 12V.
- Total output: 50W.

 **Rechargeable Battery Pack**

- Lithium-ion battery available.
- Battery low warning.

 **Size & Weight**

- 357mm(w)x275mm(d)x50mm(h) (14"x10.8"x1.9").
- 4.5kg (9.9lbs).

Appendix B: I/O Port Pin Assignments

Parallel Port

Pin	Signal	Pin	Signal
1	Strobe#	14	Auto Linefeed#
2	Data 0	15	Error#
3	Data 1	16	Initialize#
4	Data 2	17	Select In
5	Data 3	18	GND
6	Data 4	19	GND
7	Data 5	20	GND
8	Data 6	21	GND
9	Data 7	22	GND
10	ACK#	23	GND
11	Busy	24	GND
12	Paper Empty	25	GND
13	Select		

Serial Port

Pin	Signal
1	DCD (Data Carrier Detect)
2	RXD (Received Data)
3	TXD (Transmitted Data)
4	DTR (Data Terminal Ready)
5	GND (Signal Ground)
6	DSR (Data Set Ready)
7	RTS (Request To Send)
8	CTS (Clear To Send)
9	RI (Ring Indicator)

RCA Jack

Pin	Signal
1	Video-in
2	GND

Monitor Port

Pin	Signal	Pin	Signal	Pin	Signal
1	BRED	6	GND	11	N.C
2	BGREEN	7	GND	12	DDCDA
3	BBLUE	8	GND	13	DHSYNC
4	N.C	9	N.C	14	DVSYNC
5	GND	10	GND	15	DDCLK

Dual PS/2 Type Ports

Pin	Signal
1	EKDA
2	N.C
3	GND
4	VCC
5	EKCLK
6	N.C

Pin	Signal
1	EMDA
2	N.C
3	GND
4	VCC
5	EMCLK
6	N.C

Dual USB Ports

Pin	Signal
1	USB VCCA
2	USBP0-
3	USBP0+
4	GND

Pin	Signal
1	USB VCCB
2	USBP1-
3	USBP1+
4	GND

S-video Jack

Pin	Signal	Pin	Signal
1	GND	5	GND
2	CVBS	6	GND
3	XLUMA	7	GND
4	XCRMA	8	GND

PC Card Sockets

Socket A:

Pin	Signal	Pin	Signal	Pin	Signal
A1	GND	A35	GND	A69	GND
A2	A CD3	A36	A CA5	A70	A CA19
A3	A CD4	A37	A CA4	A71	A CA20
A4	GND	A38	GND	A72	GND
A5	A CD5	A39	A CA3	A73	A CA21
A6	A CD6	A40	A CA2	A74	A VCC P
A7	GND	A41	GND	A75	GND
A8	A CD7	A42	A CA1	A76	GND
A9	A CE1#	A43	A CA0	A77	A VCC P
A10	GND	A44	GND	A78	A CA22
A11	A CA10	A45	A CD0	A79	GND
A12	A OE#	A46	A CD1	A80	A CA23
A13	GND	A47	GND	A81	A CA24
A14	A CA11	A48	A CD2	A82	GND
A15	A CA9	A49	A WP#	A83	A CA25
A16	GND	A50	GND	A84	A VS2
A17	A CA8	A51	GND	A85	GND
A18	A CA13	A52	A CD1#	A86	A RESET
A19	GND	A53	A CD11	A87	A WAIT#
A20	A CA14	A54	GND	A88	GND
A21	A WE#	A55	A CD12	A89	A INPACK
A22	GND	A56	A CD13	A90	A REG#
A23	A RDYBY#	A57	GND	A91	GND
A24	A VCC P	A58	A CD14	A92	A BVD2#
A25	GND	A59	A CD15	A93	A BVD1#
A26	GND	A60	GND	A94	GND
A27	A VCC P	A61	A CE2#	A95	A CD8
A28	A CA16	A62	A VS1	A96	A CD9
A29	GND	A63	GND	A97	GND
A30	A CA15	A64	A IORD#	A98	A CD10
A31	A CA12	A65	A IOWR#	A99	A CD2#
A32	GND	A66	GND	A100	GND
A33	A CA7	A67	A CA17		
A34	A CA6	A68	A CA18		

Socket B:

Pin	Signal	Pin	Signal	Pin	Signal
A1	GND	A35	GND	A69	GND
A2	B CD3	A36	B CA5	A70	B CA19
A3	B CD4	A37	B CA4	A71	B CA20
A4	GND	A38	GND	A72	GND
A5	B CD5	A39	B CA3	A73	B CA21
A6	B CD6	A40	B CA2	A74	B VCC P
A7	GND	A41	GND	A75	GND
A8	B CD7	A42	B CA1	A76	GND
A9	B CE1#	A43	B CA0	A77	B VCC P
A10	GND	A44	GND	A78	B CA22
A11	B CA10	A45	B CD0	A79	GND
A12	B OE#	A46	B CD1	A80	B CA23
A13	GND	A47	GND	A81	B CA24
A14	B CA11	A48	B CD2	A82	GND
A15	B CA9	A49	B WP#	A83	B CA25
A16	GND	A50	GND	A84	B VS2
A17	B CA8	A51	GND	A85	GND
A18	B CA13	A52	B CD1#	A86	B RESET
A19	GND	A53	B CD11	A87	B WAIT#
A20	B CA14	A54	GND	A88	GND
A21	B WE#	A55	B CD12	A89	B INPACK
A22	GND	A56	B CD13	A90	B REG#
A23	B RDYBY#	A57	GND	A91	GND
A24	B VCC P	A58	B CD14	A92	B BVD2#
A25	GND	A59	B CD15	A93	B BVD1#
A26	GND	A60	GND	A94	GND
A27	B VCC P	A61	B CE2#	A95	B CD8
A28	B CA16	A62	B VS1	A96	B CD9
A29	GND	A63	GND	A97	GND
A30	B CA15	A64	B IORD#	A98	B CD10
A31	B CA12	A65	B IOWR#	A99	B CD2#
A32	GND	A66	GND	A100	GND
A33	B CA7	A67	B CA17		
A34	B CA6	A68	B CA18		